

SIRUDA

Performance Gaskets

Sealing Solution

INTAKE & EXHAUST MANIFOLD GASKETS
CYLINDER HEAD GASKETS

2022 Sep V4.0

English / 中文 / 日本語

A close-up photograph of a metallic engine component, likely a piston or valve cover, showing a curved surface and a small circular hole. A faint, stylized bird logo is visible in the background, partially obscured by the component's curves. The lighting is soft, highlighting the texture of the metal.

力を発揮するガスケット

充份發揮引擎效能的墊片



INTRODUCTION / 介紹 / 紹介

Established in 1988, SIRUDA high performance gasket is a renowned manufacturer of gasoline/diesel engine gaskets and overhaul kits for all major car brands. Having several decades of professional manufacturing experience, SIRUDA is also well known as the outstanding designer and developer of dies/molds for gaskets. SIRUDA high performance gaskets are manufactured through the adoption of the most advanced production techniques and equipment.

SIRUDA's goal is to provide highest quality to meet the need of the latest generation turbo-charged high speed engines running under the toughest condition. SIRUDA achieves it by controlling the entire manufacturing process - from designing, tooling, producing to the final products. Through continued product research and development, modern management and professional sales and marketing policy, SIRUDA has now become gasket of the first choice among motor sport circle.

SIRUDA continues to invest in the research and development of the latest techniques in order to create the best quality gaskets for its customers.

SIRUDA成立於1988年，是臺灣深具信譽的汽車零件生產製造商及供應商，專營製造各大品牌的引擎大修包，在汽車零件缸模製造領域有數十年專業製造的經驗，是臺灣最具規模的缸模設計及開發製造商，並採納最新技術及生產系統製造流程。

透過最嚴謹的生產流程管理與嚴格的品質控管，提供客戶從開發模具製造到成品、成型、組裝等一系列的全套制程服務。以及高度專業，高技術密集的管理服務。SIRUDA已研發出最高的品質來因應最新渦輪增壓系統的引擎並成為賽車活動的第一選擇。

SIRUDA的產品在全體員工不斷創新努力及堅持下，在汽車零件市場深耕多年並佔有一席之地，SIRUDA深刻體認產品及技術進化的趨勢，除了將鋼模製造與設計的專長技術同步整合納入產品製程化的新觀念之外，並結合汽車零件技術的市場脈動發展，不斷持續投入新技術的開發及創造優質產品的國際競爭力，不僅是SIRUDA實業永續經營不斷創新與自我超越的動力，更是SIRUDA永遠的奮鬥目標。

SIRUDAは1988年に創立され、SIRUDA ハイパフォーマンスガスケットは主要カーメーカー向けのガソリンおよびディーゼルエンジン用ガスケットのアフターパーツ製造メーカーとして高い名聲を得ています。数十年間に渡り培ってまいりましたSIRUDAのガスケット製造、生産技術、金型製造の専門技術等は業界内に広く知られるとともに製品は最新の生産設備とテクニカルによって製造されています。

厳しい製造工程管理と品質管理ルールに基づいて、SIRUDAはデザイン設計からツール、製造工程、そして完成品に至るまで徹底的な工程管理システムを行っております。製品の研究開発を通じて現代的な管理手腕と専門的シール知識、市場開拓で“SIRUDA”は今やモータースポーツ界の間でも屈指のガスケットとなりました。

全従業員の長年の英知と努力を生かし、SIRUDAの最終目標は最新世代のハイスピードエンジン用のターボチャージャーによる、いかなる過酷な走行状況下での使用に対しても最高性能のパフォーマンスを誇る事に有ります。SIRUDAは最高品質のガスケットを顧客へ提供する為に絶え間ない研究開発と最新鋭のテクニックを駆使し続ける努力を惜しみません。

Formula of Sealing



HR RUBBER COATED MATERIAL

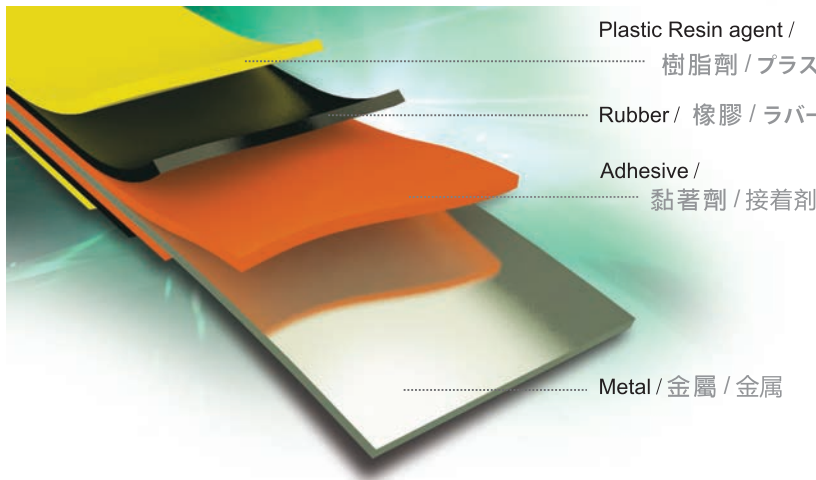

Plastic Resin agent / 樹脂劑 / プラスチック レジン.エージェント

Rubber / 橡膠 / ラバー

Adhesive / 黏著劑 / 接着劑

Metal / 金屬 / 金屬

About SGS TEST REPORT

SGS測試報告 / SGS試驗報告書
 Product Description : HR-180
 Lab Environment Conditions
 Ambient temperature : 23±2°C
 Relative humidity : 50±5%RH

JIS K6894(1996) Fluoroplastic coating film on metal substrate

GROMMETS TYPE GASKET

This type of gasket has now become a favourite choice for turbocharged highly powered engines. It endures higher surface pressure and prevents sudden gas leak caused by knocking. Grommets coated with molybdenum prevents scratching. Best sealing capability is achieved by the use of nitrile gum over the gasket surface.



這種款式的墊片已成為渦輪增壓引擎的首選，可抵抗引擎表面的高壓及避免在敲缸時瞬間的側漏。表面塗二硫化鉬的Grommets可避免刮傷。並在汽缸床墊片的表面塗裝橡膠塗料，對於密封性能有更好的效果。

グロメットタイプガスケット

このタイプのガスケットはターボチャージャーによる高出力エンジン向け選択の筆頭となりました。ノッキングによるエンジン表面の高圧と内部の漏れを防止できます。

グロメットの表面には二硫化モリブデンコーティング加工が施されており傷を防止できます。最適なシーリング性能はガスケット表面にニトリル樹脂を使うことによって密封性が向上します。

GROMMET TYPE GASKET

High-pressure resistance. Gas leakage through the sides of gasket can be prevented.

可承受高的壓力，且可防止側面洩漏的可能。

グロメットタイプガスケット

高圧力対抗。ガスケットのサイド部（側面部）からのガス漏れを防止できます。



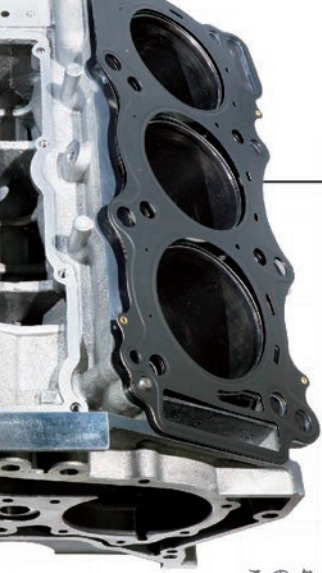

FEATURE / 特色 / 特点

Multiple Layer Steel Head Gaskets / 多層複合鋼材 / 多层メタルガスケット

This type of gasket has better strength against rebound and corrosion because it comprises of multi layers of steel. The outer layer is coated with HR-180. It has excellent sealing capability for high power engines.

透過多層複合鋼材的組成，使得此汽缸床墊片在使用時，有彈回及抵抗腐蝕，擁有更好的延展性。在多層複合鋼材表面加入HR180的表面塗裝，能使得在高馬力的引擎室內，有更好的密封性。

このタイプのガスケットは多層スチール構成によって弾力性、耐腐食性に富んだ高性能を保持しています。メタル材の表面材として独自開発によるHR180を塗付しており、高出力エンジンに対してすぐれたシーリング性能を提供しております。

FLUOROELASTOMER / 氟素橡膠 / フッ素ラバー

A Fluoroelastomer is a special purpose synthetic rubber. It has wide chemical resistance and superior performance, especially in high temperature application in different media.

HR-180 rubber coated material that is heat-resistant to 250°C / 482°F. HR-180 is designed to meet the demands of a variety of harsh sealing environments, load conditions, and surface finishes.

氟橡膠是一種合成橡膠，尤其在高溫的不同介質內，它能廣泛的抗化學物質及產生較高的成效。HR180橡膠板料能耐熱至250°C / 482°F，HR180的研發設計可克服許多嚴苛的引擎環境。

バイトンは合成ゴムですが、高温の様々な媒介で、化学物質をよく抵抗できます。HR180ゴム材は250 C / 482°F耐熱でき、HR180の開発設計は厳しいエンジン環境に対応できます。

HR RUBBER COATED MATERIAL

This coating is manufactured base on ING TIEN's exclusive HR rubber coated material technology through years of intensive research and is ideal for applications requiring high-temperature resistance sealing conditions.

Cylinder head gaskets and exhaust manifold gaskets with this coating are used in high-performance engines in automotive racing, off-road vehicles as well as motorcycles.

- **IMPROVED TEMPERATURE RESISTANCE**
HR180: The material is same as FKM. The temperature resistance is up to 250°C
- **METAL OPTIONS**
Available in stainless steel, SPCC(Steel - Plate - Cold Rolled Coil) and aluminum.
- **CUSTOMIZABLE RUBBER**
HR rubber coated material thickness can be customized based on your specific requirements. We can provide coating thickness from 0.025mm to 0.1mm.
- **IMPROVED SEALING**
HR rubber coated material has excellent flange conformity to surface irregularities which allows it to effectively seal uneven and stamped surfaces while minimizing flange finishing requirements.

Type of Gaskets

BEAD TYPE GASKET

Due to its specially-designed bead shape and heights, precise control of surface pressure can be achieved.

特殊設計的壓痕外型及高度，可達成對表面壓力的精密控制。

ビードタイプガスケット

特殊設計のビード形状と高さは表面に対する圧力をきちんとコントロールできます。



STOPPER TYPE GASKET

Stopper which is sandwiched between layers have good sealing against engine vibration. This type of gasket is also ideal for installation at narrow locations around the combustion chamber.

STOPPER 是在缸徑周圍介於複合鐵板間，在引擎震動時，能提供高密封性。這款型式的墊片，很適合安裝在燃燒室周圍較小的空間。

ストッパータイプガスケット

STOPPER はボア径周りの積層間にあり、エンジン振動に対し高い密封性能があります。このタイプのガスケットは燃焼室間同士の面接が狭い部位に対して理想的です。

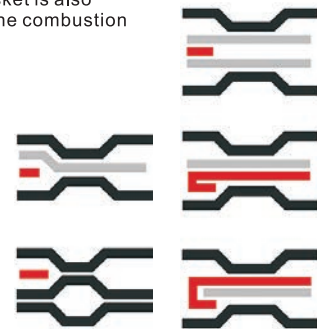



創始原由 / Origin Story of "SIRUDA"

綜觀國內外車輛競技活動的發展及為了提高引擎功率輸出等嚴苛條件下的改裝與維修之需求，使用者與相關工程人員都在不斷的努力提升車輛的整體性能與可靠性，然而，用於引擎部件密封的墊片，對於提升引擎性能與穩定性方面處於非常重要的一個環節，而且這類部件屬於耗材，因引擎維修、調整而更換的頻率很高，一直以來，國內的使用者大多是採用國外品牌的產品，除價格非常高昂外，部品種類的多樣性與完整性亦讓使用者花上更多的時間與精力，尤其是資訊相對不流通以及語言的問題，常發生部品不合用、使用方式不正確或是有問題卻不知如何取得正確的答案與解決方法...等。

有鑑於此，印田實業於2010年11月推出專為追求引擎效能極限而成的品牌 – **SIRUDA**

Due to the rigorous demands of domestic and international motorsport activities, drivers and mechanics constantly pursue increased levels of performance and reliability from their engines. The head gasket is a key component of engine performance, providing sealing capability and reliable power output. Domestic users often choose head gaskets imported from overseas to meet their engine overhaul and rebuild needs, not taking into consideration the high cost of import, a large range of products unable to meet specific individual needs, product support issues such as language barriers, incorrect installation/application, or unable to resolve technical issues.

"Siruda" was established in November 2010 by Ing Tien Enterprise Co. Ltd (ITE) in pursuit of the ultimate in internal combustion engine performance.

カーレースの発展によりエンジンの出力を引き上げるため、様々な酷な条件に耐えうる改造やメンテナンスの需要は海外にのみならず、国内にも増えつつあります。ユーザーたちも業者たちも車の性能を引き上げるために努力を重ねています。シールに用いるエンジン部品の一つであるガスケットは、エンジンの性能や安定性において大変重要な役割を担っています。また消耗品であるため、エンジンのメンテナンスまたは調整により頻繁に変えます。いままで国内の多くのユーザーたちは海外ブランドの製品を使うことが多いですが、これは値段が高い上に、部品自体も多種多様で適用性の問題もあるため、ユーザーたちに余計な時間と手間を掛けさせることがあります。特に情報伝達の不便や言葉による誤りで、部品が適用しないことや、正しく使われてないことなど多々あります。

問題があるのに解決方法や答えをどうやって見つけるか分からない人達のために、印田実業が2010年11月より専らエンジン性能を最大限に引き出すためのブランドを作り上げました。それが、**SIRUDA**です。

Logo Designs history

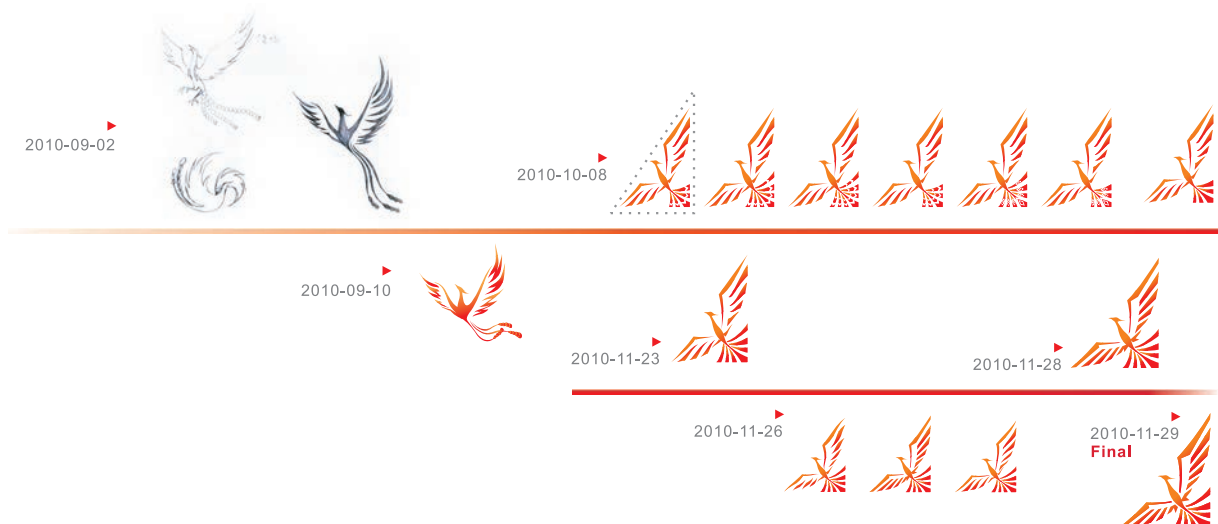

名稱源自於印田～日文漢字的假名拼音SIRUSIDA簡化而來，以鳳凰做為圖形標誌，其發想原點是百鳥之王的高貴與浴火重生的形象，且不論於中西海外都有著相同的印象與傳說；對於此品牌的決心與期許，鳳凰的意象符合印田實業不斷創新及向上的精神，並表達出高水準品牌的定位，以及引擎經過SIRUDA的支持而重新獲得新生命並再次輝煌的意境。

The name "SIRUDA" is derived from the Japanese kanji spelling of our parent company. Using a phoenix as the company logo, a sense of high quality and rejuvenated life is conveyed. The same philosophy can be found in Western as well as Eastern cultures: a sense of continual innovation and striving for excellence, always climbing upward, represented by a phoenix and driven by ITE' passion. With SIRUDA' support, engines are given new life and a new lease on showcasing their performance.

名称は印田の漢字の読み方SIRUSIDAから変化してきたものです。マークは鳳凰のイメージで、鳥の王者の貴さと火から蘇るイメージは発想の原点です。また、東西を問わずに同じイメージと伝説があります。このブランドに対する決心と希望は鳳凰のマークを通して、印田実業の革新と進み続ける精神を表しています。また、貴いイメージはハイレベルのブランドであることを表します。そして、エンジンはSIRUDAにより再び新たな命を得て輝き出すでしょう。



經過手稿的概念繪製以及討論，確認將原本偏有機形的圖形標誌改變設計手法，朝向符合實用性與貼近未來潮流的幾何造型，所以在結構上增加了三角構形的概念，並在後續標誌的創造與修正過程中，增加了展翅向上的概念，加深了重生之後往前與往上更進一步的期待與目標。

After initial concept hand drawings verified the original pattern, changes were made that oriented the design toward practical use and future trends. Three-dimensional geometrical shapes were added, and the logo was further refined to add an element of wingspan, symbolizing the idea of soaring up towards a higher goal.

発想から下書きと議論を重ねて、設計を生き物のような形より実用的且つ未来的の幾何模様に変更を決めて、構造に三角形を取り入れました。後マークの創作と修正の中にさらに翼を羽ばたく概念も取り入れて、再生を得て更なる進化を遂げると期待と目標も込めました。

圖形化字體符號標誌源自於Decipher這組字型修改而來，造型修改為較符合現下流行使用的習慣與些許提升工整化，顏色是略帶沉穩與熱情的暗紅色為主，單色化的設定給予心理上一種專業而強烈的感受。

The logo design and name comes from the Decipher font. The look and feel was refined with a modern design, with the dark red color as the primary color theme conveying a sense of passion and stability. A simplified color design gives a strong professional presence

図形化した文字マークはDecipherというフォントに手を加えてきました。少し現代の流行りに合わせ、形を整えるように修正してみました。色は落ち着きと情熱を持ち合わせる暗赤色をメインとしています。単色の設定は心に専門と強烈な印象を与えます。

Original font type : Decipher

SIRUDA

SIRUDA

本格
技術

Revolution

印田實業過去在一般民用與保修用途所銷售之墊片產品，在市場以及同業間有著良好的口碑與高品質的產品與服務，對於新產品的開發、技術及材料的研究與應用也不遺餘力，針對提高性能目的市場所推出的品牌，可說是印田實業投入以最高的生產技術、材料、結構設計等自我要求所生產的高水準產品。

事實上，自2011以來，**SIRUDA** 通過國內外許多正規賽事以及日本D1等嚴格的考驗，其品質相比海外其他知名品牌的產品也不惶多讓，並且對於國內市場的服務也比國外品牌更全面，更能聽到各位使用者的心聲與需求，尤其在新產品的合作與開發，更是讓各方充滿期待與驚喜。

合理的產品價位，最高水準的品質，可靠且有效的使用體驗，全面且專業的相關服務，未來也是以世界級一流的品牌價值為目標，繼續與各位一同前進。

ING TIEN Enterprise Co. Ltd. has a long history of providing exceptional flat gasket products for the OE replacement market, with strong brand reputation, high quality gaskets exceeding OEM quality, and top-tier service support. By taking our expertise in R & D, manufacturing, and material design, developing new high performance products for aftermarket customers is the next step in high quality product offerings for the market.

Since 2011, SIRUDA products have been proven on the most demanding circuits by some of the most experienced drivers, from domestic sanctioned races to D1 drivers in Japan. The quality and design of SIRUDA products are on the same level as top gasket manufacturers worldwide, and our support for domestic customers is more comprehensive than overseas brands. By listening carefully to customer requests and demands on existing and new product development, we can easily meet and exceed all expectations.

World-class product and brand, exceptional quality and reliability, unmatched industry experience, with comprehensive and professional service at a reasonable price point: we will drive your success!

印田實業が一般用とアフター用に販売してるガスケット製品は、その質やサービスは以前よりアフターマーケット及び同業者の間に高い評価を得ています。新製品の開発や技術と材料の研究と応用も力を入れています。ブランドはより高い性能を求めるマーケットに対して、印田實業が最高の製造技術と材料と構造設計を持つてのハイレベル製品です。

実際に2011年より、SIRUDAは国内と海外のレース及び日本D1などの厳しい試練を突破してきました。その品質は他の海外有名ブランドと比べても遜色ないものです。また、国内市場のサービスも海外ブランドより万全で、みなさんの声や需要をより聞こえます。特に新製品の協力と開発はお客様のみなさんに期待と驚きをもたらします。

合理的な価格に最高レベルの品質、有効で頼れる使用体験、全面的且つ専門的なサービス、これからも価値ある世界級一流ブランドを目標として、皆さんとともに進んでいきます。





1 Laser welding / 鐳射焊接 / レーザー溶接

2 Plastic Resin Coated / 樹脂塗佈 / プラスチック樹脂が覆われました

3 HR-180 Rubber Coated Material / 橡膠材料塗佈 / HR-180ラバーは材料を覆いました



Sealing Solution 密封解決方案

INTAKE & EXHAUST MANIFOLD GASKETS
CYLINDER HEAD GASKETS



FORD

JTJA / JTJB
FOCUS RS

P.09

GM

ATSL

P.11

HONDA

B16A
B16A / B18C
B18A
B20B
D15B / D17A
D15B2
D16A1
D16Y5
D17A2/D17A9
F20C1/F20C2
F22C1
F23A
H22A/H22A7
H23A
K20A/K20A1
K20A4/K24A
K20C3
L15B
L15B2
L15B7
R18A

P.13

HYUNDAI

Theta II RS T-MPi 2.0L
G4KF 2.0L

P.27

MAZDA

13B MSP
B6
BP
BP-ZE
FS
L3 / LF
L5(L3/LF)N
L8 / CGBA

P.29

MITSUBISHI

4B11T
4G63 / 4G63T
4G93

P.33

NISSAN

CA18DET
FE6T
KA24
QR20DE / QR25DE
RB20DET
RB26DETT
RB25DET
SR20DET / VE
SR20DI
TB48DE
VD30DTT / VG30DTT
VG30DETT
VK56VD
VQ35DE
VR38DETT

P.37

PRINCE ENGINE

EP3 / R56
EP6 / R56

P.53

SUBARU

EJ18 / EJ20 / EJ25
EJ207
EJ253 / EJ255 / EJ257
FA20 / FB20

P.55

SUZUKI

M13A / M15A

P.63

TOYOTA

1JZ-GTE
2JZ-GE
2JZ-GTE
4AG(16V) / 4AG(20V)
7A-FE
FA20 / FB20

P.65

VOLKSWAGEN

BZB (EA888)
BV-R

P.71



SIRUDA



SPECIFICATION

FORD

Metal Head Gasket For 2.3L EcoBoost 2261CC 350HP - FOCUS RS 2016~、FOCUS ST 2019~、MUSTANG 2015~

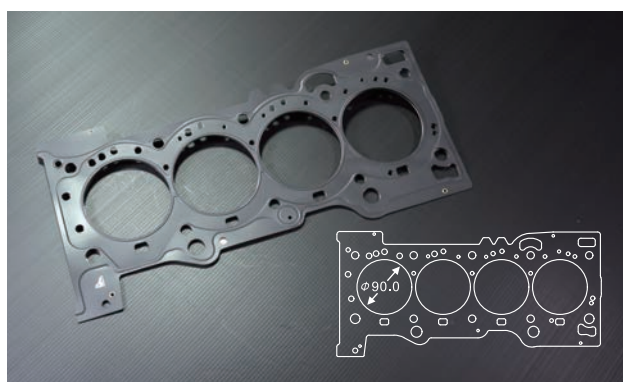

Thickness	Bore	Part No.	Type
0.85mm	90.00mm	CH140330-RB0	STOPPER
0.90mm	90.00mm	CH140330-RB1	
1.20mm	90.00mm	CH140330-RB4	

Metal Head Gasket For JTJA / JTJB,1.6L

C-MAX / FIESTA / FOCUS TURNIER / GALAXY 2010~

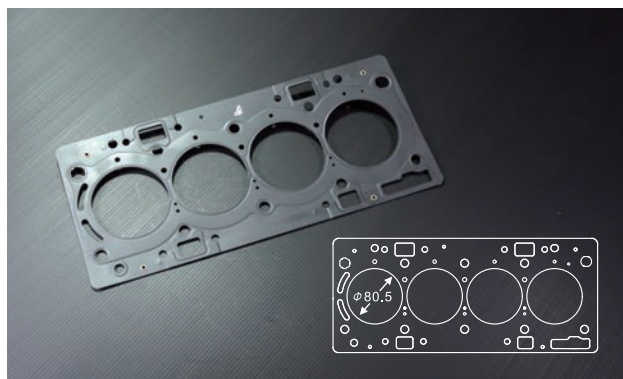

Thickness	Bore	Part No.	Type
0.60mm	80.50mm	CH141180-RC0	STOPPER
0.65mm	80.50mm	CH141180-RC1	



SPECIFICATION

GM

Metal Head Gasket For 2.5L

CHEVROLET CAMARO 2.0 TURBO 2016~

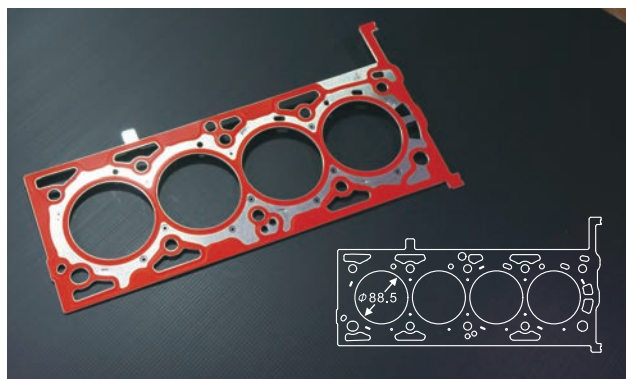

Thickness	Bore	Part No.	Type
1.30mm	88.50mm	CH210970-RD2	STOPPER
1.50mm	88.50mm	CH210970-RD1	

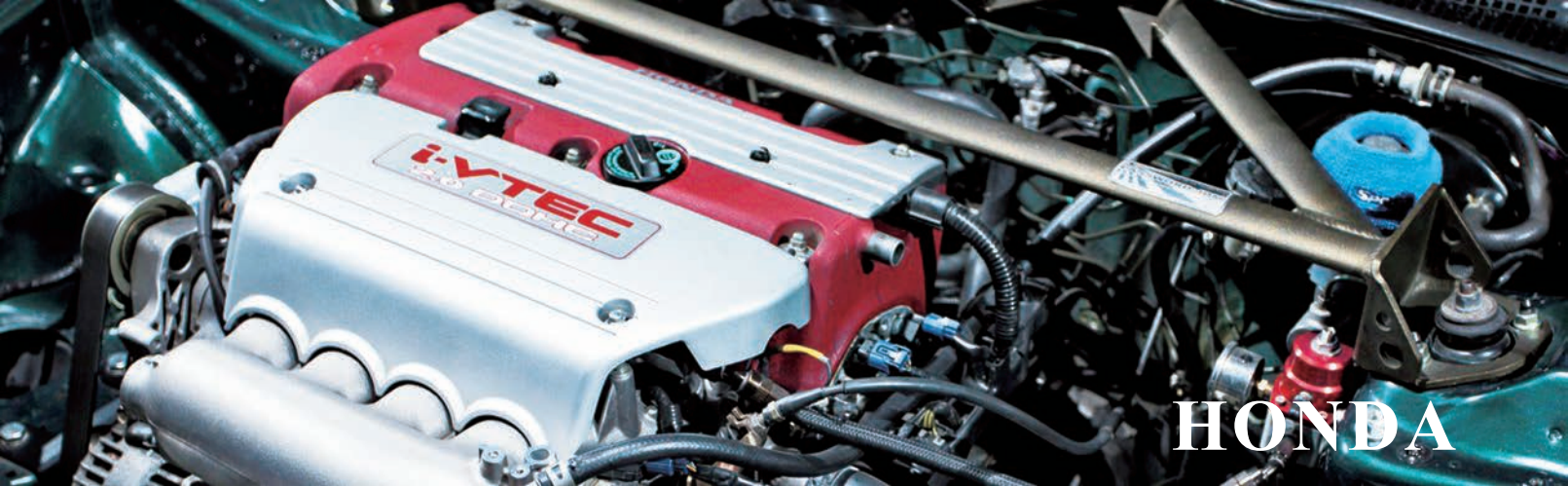

SPECIFICATION

HONDA

Metal Head Gasket For B16A

CIVIC EF SIR EG6

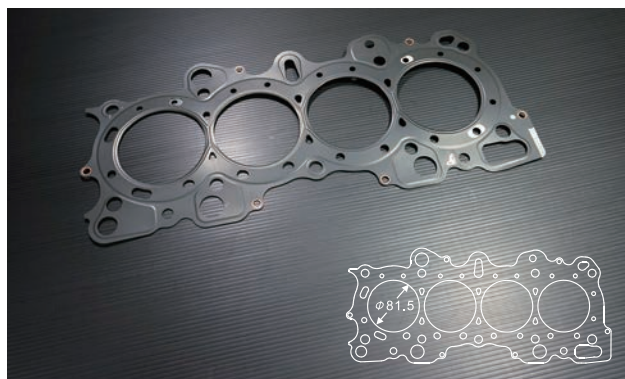

Thickness	Bore	Part No.	Type
0.40mm	81.50mm	CH040010-RD6	
0.85mm	81.50mm	CH040010-RD0	
1.30mm	81.50mm	CH040010-RD5	STOPPER
2.10mm	81.50mm	CH040010-RD3	

Metal Head Gasket For B16A

CIVIC TYPE-R EK9

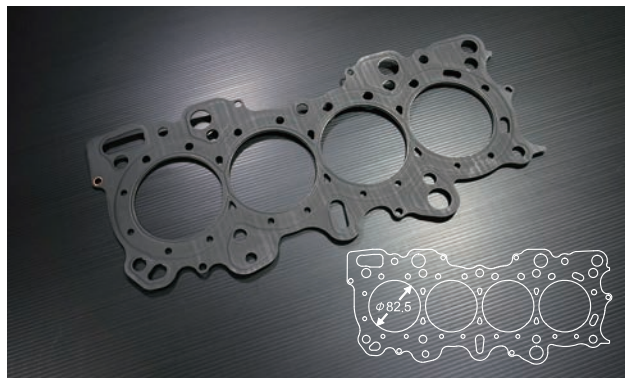

Thickness	Bore	Part No.	Type
0.70mm	82.50mm	CH040990-RC0	
0.90mm	82.50mm	CH040990-RC1	STOPPER
1.10mm	82.50mm	CH040990-RC2	

Metal Head Gasket For B16A / B18C

INTERGRA TYPE-R DC2



Thickness	Bore	Part No.	Type
0.85mm	85.00mm	CH041080-RA1	
1.30mm	85.00mm	CH041080-RA0	STOPPER

Metal Head Gasket For B18A

INTERGRA DB1

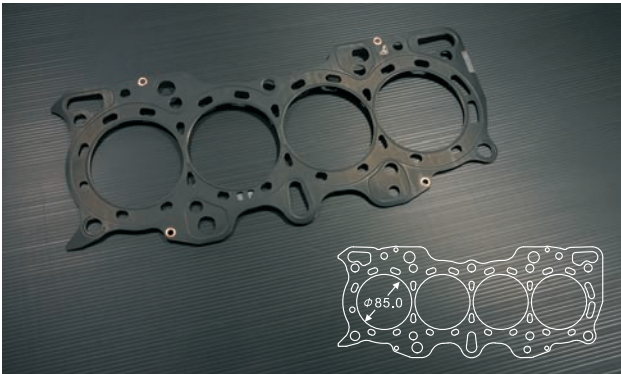

Thickness	Bore	Part No.	Type
0.85mm	85.00mm	CH041090-RA0	STOPPER

Metal Head Gasket For B20B

CR-V MK-I RD1,RD2

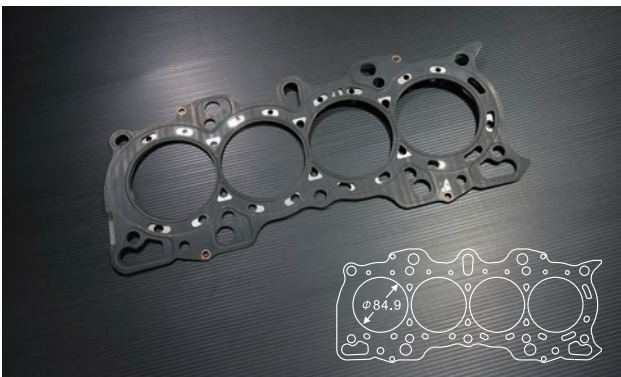

Thickness	Bore	Part No.	Type
0.85mm	84.90mm	CH040030-RE0	STOPPER
2.10mm	84.90mm	CH040030-RE1	

Metal Head Gasket For B20B

CR-V

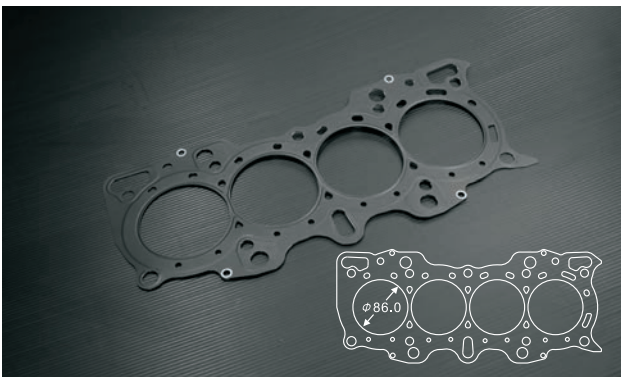

Thickness	Bore	Part No.	Type
0.40mm	86.00mm	CH041170-RB2	STOPPER
0.70mm	86.00mm	CH041170-RB1	
0.85mm	86.00mm	CH041170-RB0	

Metal Head Gasket For D16Y5

CIVIC K8,EK3



Thickness	Bore	Part No.	Type
0.40mm	76.00mm	CH040070-RE5	STOPPER
0.85mm	76.00mm	CH040070-RE0	
1.10mm	76.00mm	CH040070-RE1	
1.60mm	76.00mm	CH040070-RE2	
2.10mm	76.00mm	CH040070-RE4	

Metal Head Gasket For D16Y5

CIVIC K8,EK3



Thickness	Bore	Part No.	Type
0.40mm	78.00mm	CH040070-RG5	STOPPER
0.85mm	78.00mm	CH040070-RG0	
1.10mm	78.00mm	CH040070-RG1	
1.50mm	78.00mm	CH040070-RG2	
2.00mm	78.00mm	CH040070-RG3	
1.75mm	78.00mm	CH040070-RG6	

Metal Head Gasket For D15B / D17A

CIVIC K10,ES3



Thickness	Bore	Part No.	Type
1.30mm	76.00mm	CH040050-RB1	STOPPER

Metal Head Gasket For D17A2 / D17A9

CIVIC K10,ES3



Thickness	Bore	Part No.	Type
1.30mm	76.00mm	CH040430-RB1	STOPPER

Metal Head Gasket For H22A

ACCORD EURO-R CL1



Thickness	Bore	Part No.	Type
0.85mm	88.00mm	CH040110-RB0	STOPPER
1.30mm	88.00mm	CH040110-RB2	
2.10mm	88.00mm	CH040110-RB1	

Metal Head Gasket For H22A7

ACCORD TYPE-R CH1, PRELUDE TYPE-S BB6



Thickness	Bore	Part No.	Type
0.85mm	88.00mm	CH040120-RC0	STOPPER
2.10mm	88.00mm	CH040120-RC1	

Metal Head Gasket For H23A

PRELUDE SI BB2/SR CC7



Thickness	Bore	Part No.	Type
0.85mm	88.00mm	CH040130-RB0	STOPPER
2.10mm	88.00mm	CH040130-RB1	

Metal Head Gasket For F23A

ACCORD LX, EX, SOHC / VTEC CG5



Thickness	Bore	Part No.	Type
0.85mm	87.00mm	CH040100-RD0	STOPPER
1.30mm	87.00mm	CH040100-RD2	

Metal Head Gasket For K20A1

CIVIC TYPE-R DC5, EP3



Thickness	Bore	Part No.	Type
0.40mm	87.00mm	CH040140-RF0	STOPPER
0.85mm	87.00mm	CH040140-RH1	
1.35mm	87.00mm	CH040140-RH2	
1.60mm	87.00mm	CH040140-RH3	

Metal Head Gasket For K20A1

CIVIC TYPE-R DC5, EP3

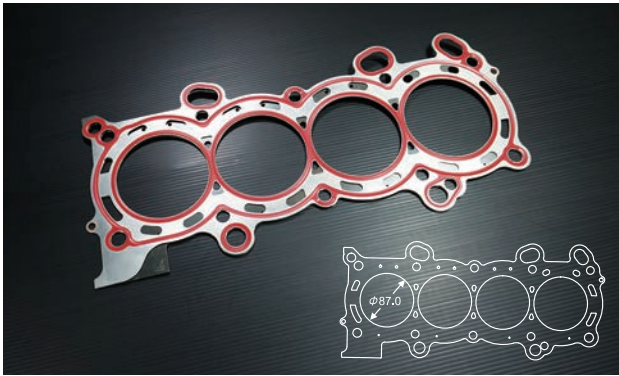

Thickness	Bore	Part No.	Type
0.85mm	87.00mm	CH040140-RG0	STOPPER

Metal Head Gasket For K20A1

DC5, EP3

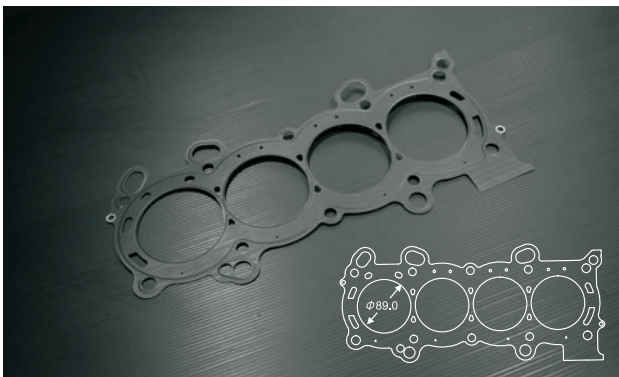

Thickness	Bore	Part No.	Type
0.40mm	89.00mm	CH041160-RB2	STOPPER
0.70mm	89.00mm	CH041160-RB1	
0.85mm	89.00mm	CH041160-RB0	

Metal Head Gasket For K20A1

02-05 ACURA RSX HONDA CIVIC SI 2.0L DOHC VTEC K20A1 / A3

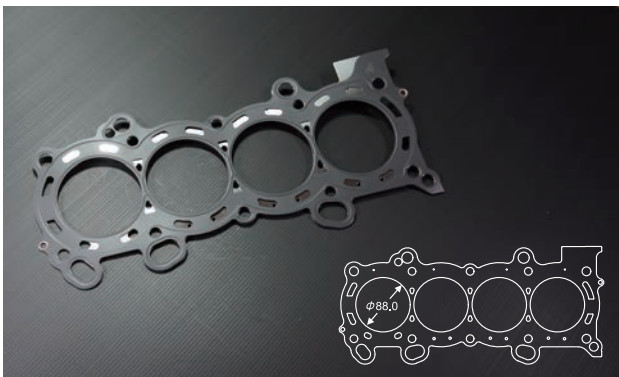

Thickness	Bore	Part No.	Type
0.85mm	88.00mm	CH041250-RB0	STOPPER
1.10mm	88.00mm	CH041250-RB1	
1.35mm	88.00mm	CH041250-RB2	

Metal Head Gasket For K20A4 / K24A

CIVIC TYPE-R FD2

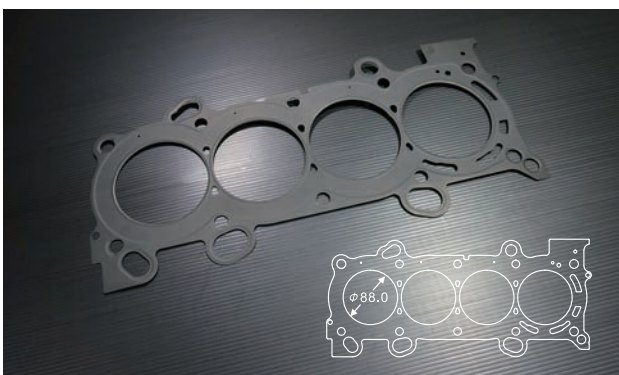

Thickness	Bore	Part No.	Type
0.40mm	88.00mm	CH040700-RB1	STOPPER
0.75mm	88.00mm	CH040700-RB0	
1.00mm	88.00mm	CH040700-RB2	
1.50mm	88.00mm	CH040700-RB3	

Metal Head Gasket For K20A4 / K24A

CIVIC ,ACCORD,CR-V

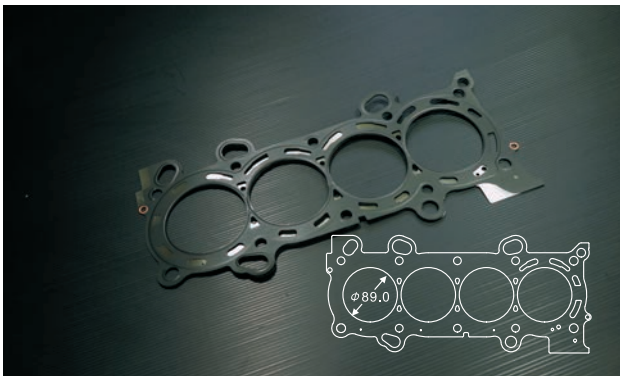

Thickness	Bore	Part No.	Type
0.40mm	89.00mm	CH041180-RB0	STOPPER
0.70mm	89.00mm	CH041180-RB1	

Metal Head Gasket For K20C3 / K20C1

ACCORD SEDAN,CIVIC 5-DOOR 2017-2020



Thickness	Bore	Part No.	Type
0.80mm	87.00mm	CH041380-RB0	GROMMET
0.95mm	87.00mm	CH041380-RB1	

Metal Head Gasket For K20C3 / K20C1

ACCORD SEDAN,CIVIC 5-DOOR 2017-2020



Thickness	Bore	Part No.	Type
0.70mm	86.80mm	CH041390-RB0	STOPPER
0.95mm	86.80mm	CH041390-RB2	

Metal Head Gasket For K20C3 / K20C1

ACCORD SEDAN,CIVIC 5-DOOR 2017-2020



Thickness	Bore	Part No.	Type
0.85mm	87.00mm	CH041440-RB0	STOPPER

Metal Head Gasket For K20C3 / K20C1

ACCORD SEDAN, CIVIC 5-DOOR 2017-2020



Thickness	Bore	Part No.	Type
0.85mm	88.50mm	CH041450-RB0	STOPPER

Metal Head Gasket For F20C1 / F20C2

S2000 AP1/AP2



Thickness	Bore	Part No.	Type
0.40mm	88.00mm	CH040890-RE0	
0.80mm	88.00mm	CH040890-RE1	
1.10mm	88.00mm	CH040890-RE2	STOPPER
1.20mm	88.00mm	CH040890-RE3	
1.60mm	88.00mm	CH040890-RE4	

Metal Head Gasket For F20C1 / F20C2

S2000 AP1/AP2



Thickness	Bore	Part No.	Type
0.40mm	89.00mm	CH041130-RA0	
0.80mm	89.00mm	CH041130-RA1	
0.90mm	89.00mm	CH041130-RA4	STOPPER
1.10mm	89.00mm	CH041130-RA2	
1.20mm	89.00mm	CH041130-RA3	

Metal Head Gasket For L15B

VEZEL 2013~、FIT/JAZZ 2013~、CITY 2014~

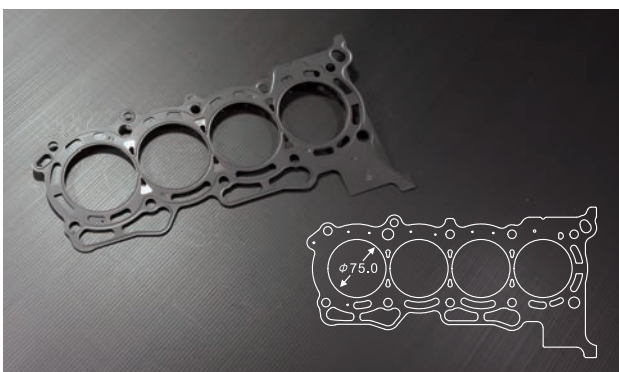

Thickness	Bore	Part No.	Type
0.60mm	75.00mm	CH041360-RB3	
1.00mm	75.00mm	CH041360-RB2	STOPPER

Metal Head Gasket For L15B2

VEZEL 2013~、FIT / JAZZ 2013~、CITY 2014~

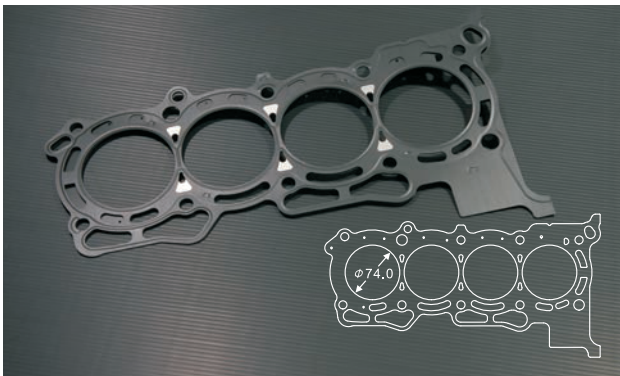

Thickness	Bore	Part No.	Type
0.35mm	74.00mm	CH041220-RB1	STOPPER
0.60mm	74.00mm	CH041220-RB0	

Metal Head Gasket For L15B2

VEZEL 2013~、FIT/JAZZ 2013~、CITY 2014~

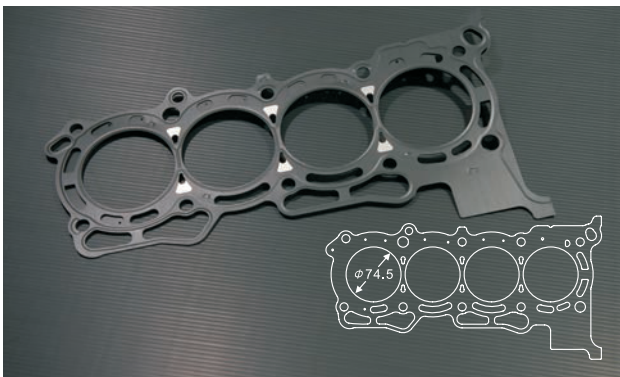

Thickness	Bore	Part No.	Type
0.35mm	74.50mm	CH041300-RA1	STOPPER
0.60mm	74.50mm	CH041300-RA0	

Metal Head Gasket For L15B7

CIVIC X 1.5 2015~

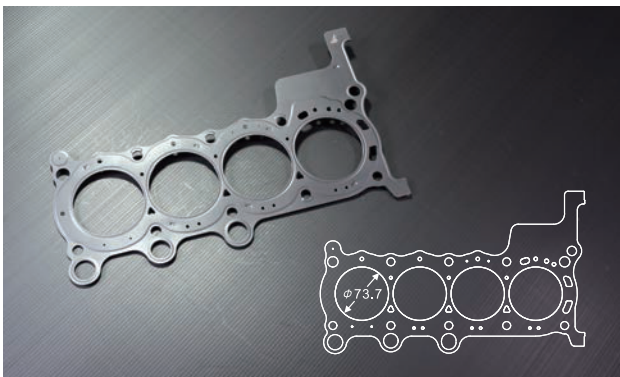

Thickness	Bore	Part No.	Type
0.60mm	73.70mm	CH041230-RB0	STOPPER
1.20mm	73.70mm	CH041230-RB1	

Metal Head Gasket For L15B7

CIVIC X 1.5 2015~

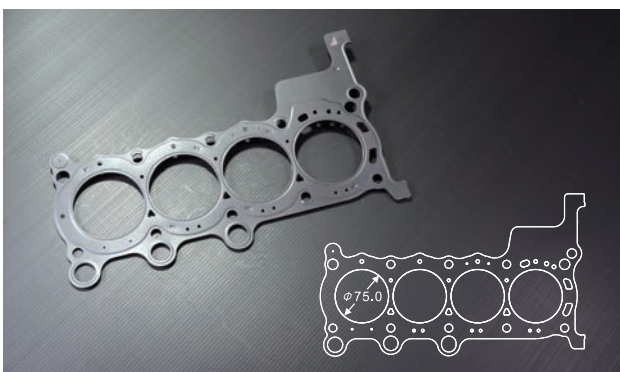

Thickness	Bore	Part No.	Type
0.85mm	75.00mm	CH041420-RB0	STOPPER

Metal Head Gasket For R18A 2019 HONDA HR-V EX-L SPORT UTILITY 4-DOOR 1.8L 1799CC L4 GAS SOHC NATURALLY ASPIRATED

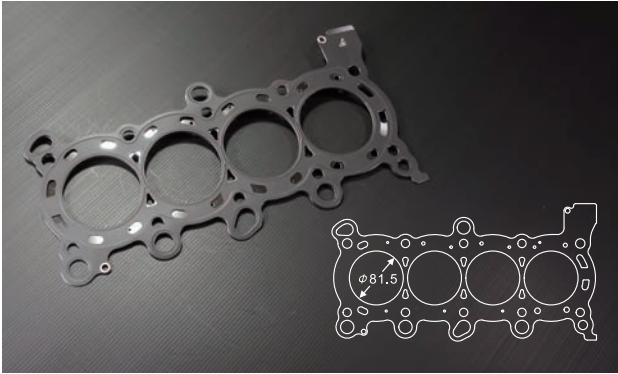

Thickness	Bore	Part No.	Type
0.80mm	81.50mm	CH040480-RE0	STOPPER
1.00mm	81.50mm	CH040480-RE1	
1.20mm	81.50mm	CH040480-RE2	

Exhaust Manifold Gasket For D16A1

HONDA CIVIC TYPE-R , FK2 EARTH DREAMS

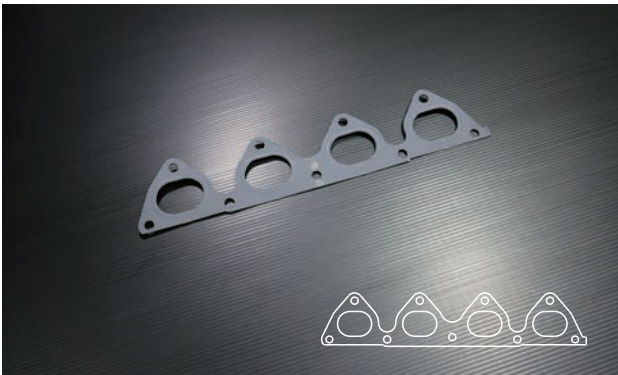

Thickness	Bore	Part No.	Type
0.65mm	N/A	EX040070-RB0	BEAD

Exhaust Manifold Gasket For D15B2

HONDA CIVIC TYPE-R , FK2 EARTH DREAMS



Thickness	Bore	Part No.	Type
0.75mm	N/A	EX040060-RC0	BEAD

Exhaust Manifold Gasket For B16A

HONDA CIVIC TYPE-R , FK2 EARTH DREAMS



Thickness	Bore	Part No.	Type
0.50mm	N/A	EX040010-RC0	BEAD

Exhaust Manifold Gasket For B16A

HONDA CIVIC FERIO SI 1996~2000,



Thickness	Bore	Part No.	Type
1.00mm	N/A	EX040012-RA0	BEAD

Exhaust Manifold Gasket For B20B

HONDA CIVIC TYPE-R , FK2 EARTH DREAMS



Thickness	Bore	Part No.	Type
0.25mm	N/A	EX040030-RC0	BEAD

Exhaust Manifold Gasket For K20A

HONDA CIVIC TYPE-R , FK2 EARTH DREAMS



Thickness	Bore	Part No.	Type
0.50mm	N/A	EX040140-RA0	BEAD

Intake Manifold Gasket For K20A1

HONDA CIVIC TYPE-R , FK2 EARTH DREAMS



Thickness	Bore	Part No.	Type
0.25mm	N/A	IN040140-RB0	BEAD

Exhaust Manifold Gasket For K20A

2007-2011 HONDA CIVIC TYPE R ,2002-2008 HONDA ACCORD EURO R



Thickness	Bore	Part No.	Type
0.80mm	N/A	EX040140-RE0	BEAD

Exhaust Manifold Gasket For F20C1 / F22C1

S2000 AP1/AP2



Thickness	Bore	Part No.	Type
0.40mm	N/A	EX040400-RA0	BEAD

Intake Manifold Gasket For B16A

HONDA CIVIC TYPE-R , FK2 EARTH DREAMS



Thickness	Bore	Part No.	Type
0.60mm	N/A	IN040010-RC0	BEAD

Intake Manifold Gasket For D16Y5

HONDA CIVIC TYPE-R , FK2 EARTH DREAMS



Thickness	Bore	Part No.	Type
0.30mm	N/A	IN040070-RA0	BEAD

Intake Manifold Gasket For F20C1/F22C1

S2000 AP1/AP2



Thickness	Bore	Part No.	Type
0.25mm	N/A	IN040400-RA0	BEAD

Full Set For B16A

CIVIC IV~VI, CRX II~III, INTEGRA 1.8

Part No.

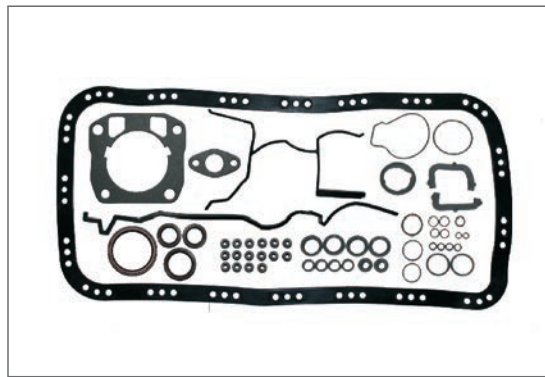

FS040010-RZG

Full Set For B20B

CIVIC IV~VI, CR-V I 2.0, CRX III, INTEGRA 1.8

Part No.

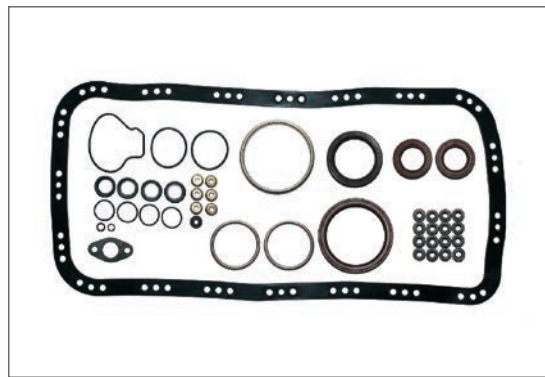
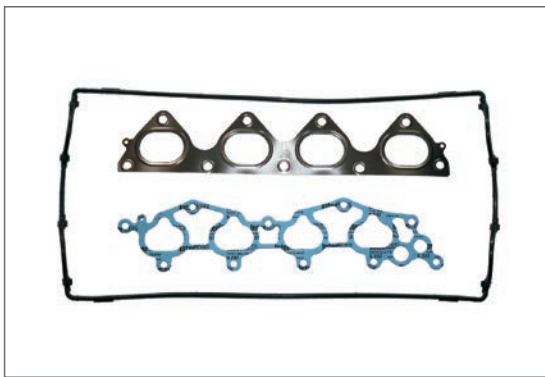

FS040030-RZB

Full Set For D16Y5

ACCORD VI, CIVIC V~VI, CR-V III, HR-V

Part No.

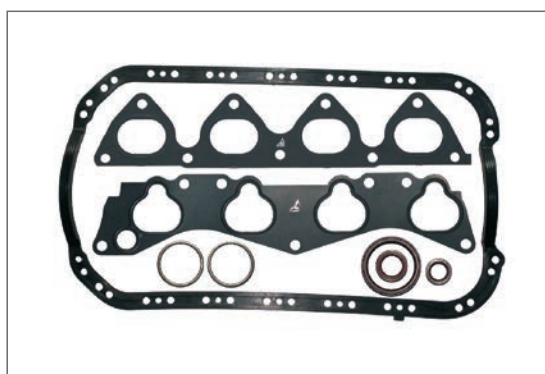
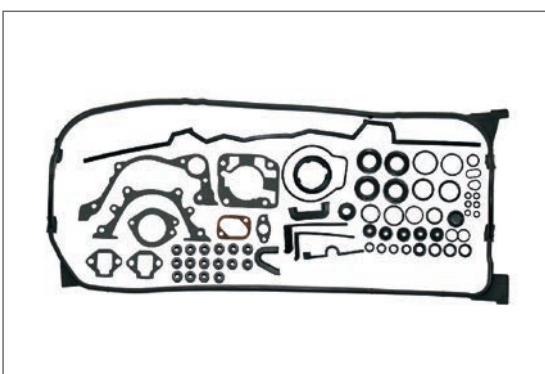

FS040070-RZD

Full Set For K20A1

ACCORD VII ,CIVIC VII~VIII ,CR-V II ,STREAM 2.0

Part No.

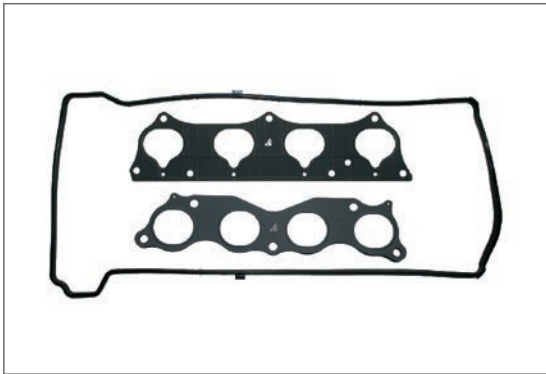

FS040140-RZ0

Full Set For F20C1

S2000 2.0, 2.2

Part No.

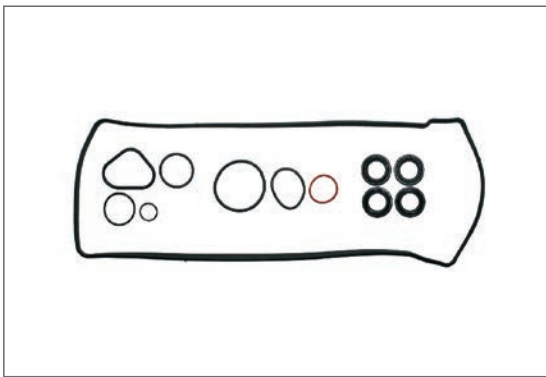

FS040400-RZ0

Full Set For K24A

ACCORD VII ,CR-V III

Part No.

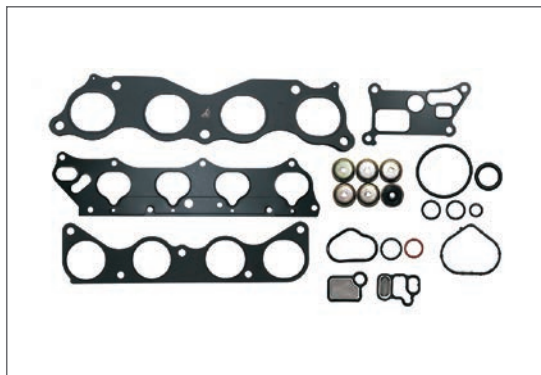
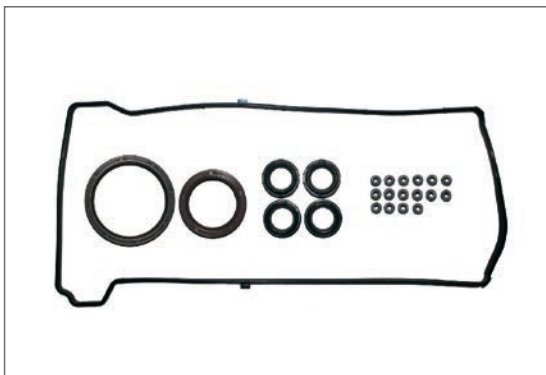

FS040700-RZA



HYUNDAI

SPECIFICATION

HYUNDAI

Exhaust Manifold Gasket For Theta II RS T-MPi 2.0 L

GENESIS COUPE 2.0T 2008-2014

Thickness	Bore	Part No.	Type
1.00mm	42.20mm	EX260742-RA0	BEAD



Exhaust Manifold Gasket For G4KF 2.0L

SONATA 2015~2019 ,SANTA FE 2016~2019

Thickness	Bore	Part No.	Type
1.00mm	46.10mm	EX260743-RA0	BEAD



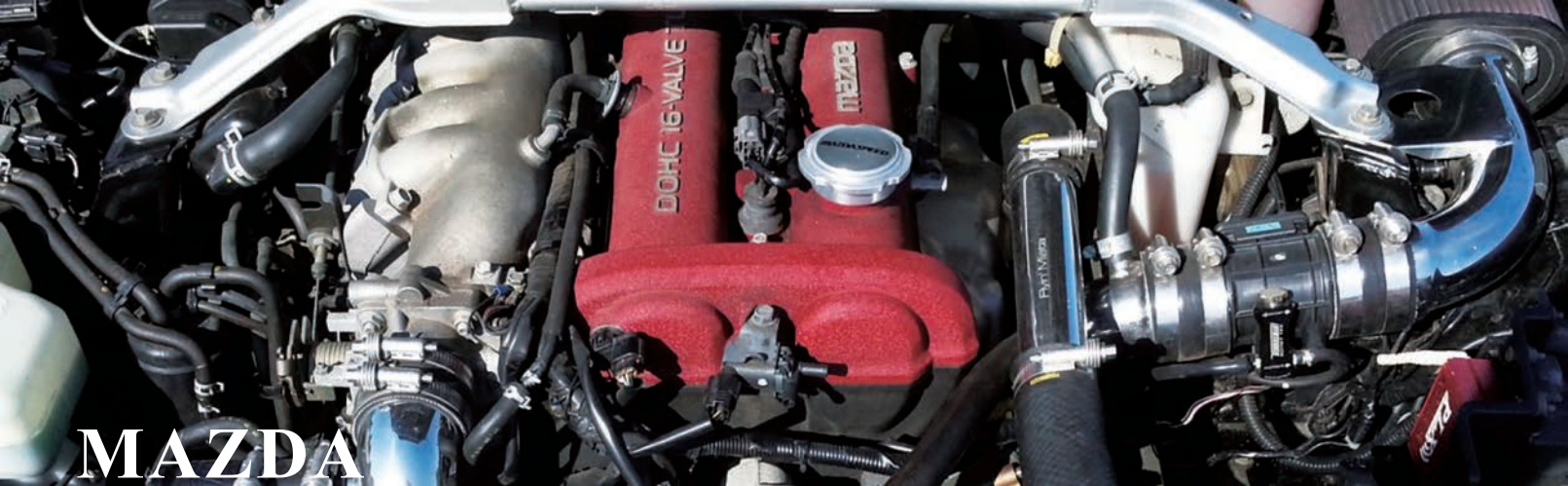

SPECIFICATION

MAZDA

Metal Head Gasket For B6 (MX-5)

323 1.6 GTX

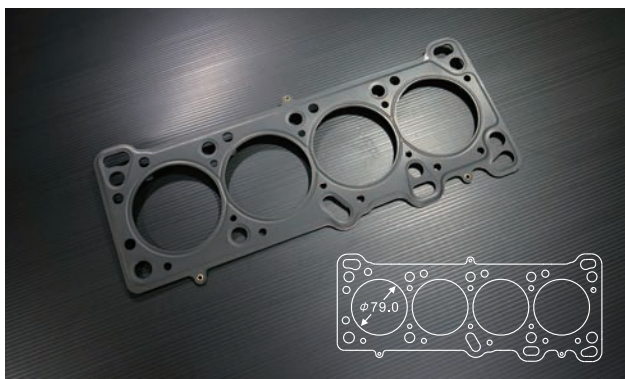

Thickness	Bore	Part No.	Type
1.20mm	79.00mm	CH071100-RA0	STOPPER

Metal Head Gasket For BP (MX-5)

BP-Z3 MX-5 1.8 DOHC



Thickness	Bore	Part No.	Type
1.00mm	85.80mm	CH071110-RA0	STOPPER
1.20mm	85.80mm	CH071110-RA1	

Metal Head Gasket For BP-ZE

BP-ZE MX-5 1.8 DOHC NB8C

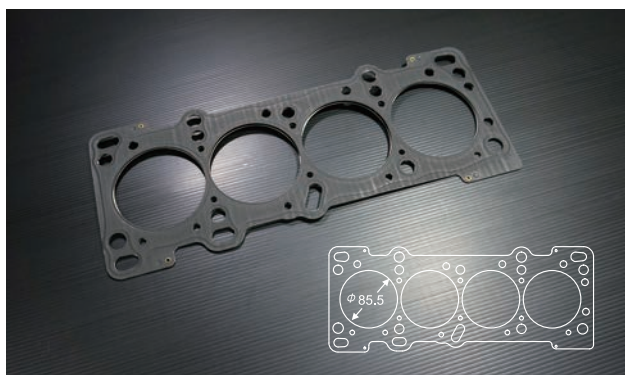

Thickness	Bore	Part No.	Type
0.80mm	85.50mm	CH071290-RC0	STOPPER
1.00mm	85.50mm	CH071290-RC1	

Metal Head Gasket For FS

MAZDA 626 2.0 16V

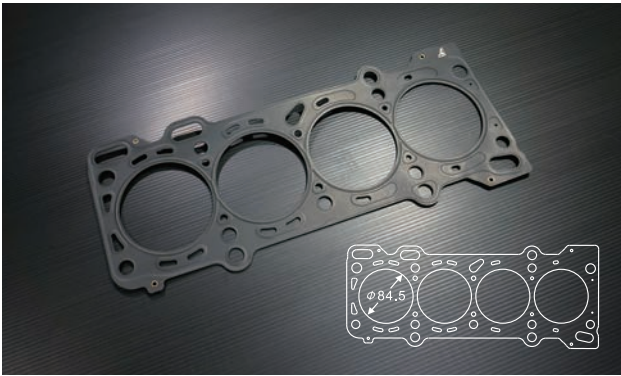

Thickness	Bore	Part No.	Type
0.70mm	84.50mm	CH070060-RD0	
1.20mm	84.50mm	CH070060-RD2	STOPPER
2.00mm	84.50mm	CH070060-RD1	

Metal Head Gasket For L3 / LF

LF-DE/VE MAZDA 3,6 2.0/2.3 MZR



Thickness	Bore	Part No.	Type
0.60mm	89.50mm	CH070360-RH3	
1.00mm	89.50mm	CH070360-RH2	STOPPER
1.20mm	89.50mm	CH070360-RH1	

Metal Head Gasket For L5

MAZDA 3,6 / MX-5 2.0/2.3

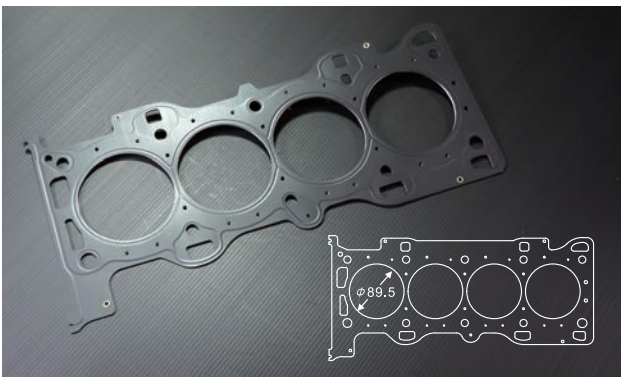

Thickness	Bore	Part No.	Type
1.20mm	89.50mm	CH071040-RH2	STOPPER

Metal Head Gasket For L8 / CGBA

LF-DE/VE MAZDA 3,6 2.0/2.3 MZR



Thickness	Bore	Part No.	Type
1.20mm	85.00mm	CH070370-RF3	STOPPER

Exhaust Manifold Gasket For 13B MSP

RX-8 13B-MSP

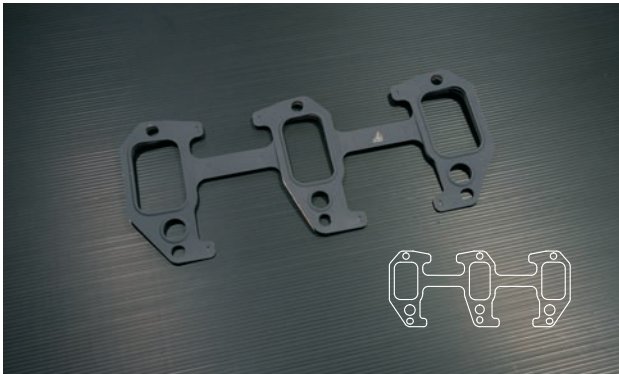

Thickness	Bore	Part No.	Type
1.00mm	N/A	EX071510-RA0	BEAD

Intake Manifold Gasket 13B MSP

RX-8 13B-MSP



Thickness	Bore	Part No.	Type
2.80mm	N/A	IN071510-RA0	BEAD

Gasket For 13B MSP

RX-8 13B-MSP



Thickness	Bore	Part No.	Type
0.25mm	10.00mm	PS071510-RA0	BEAD

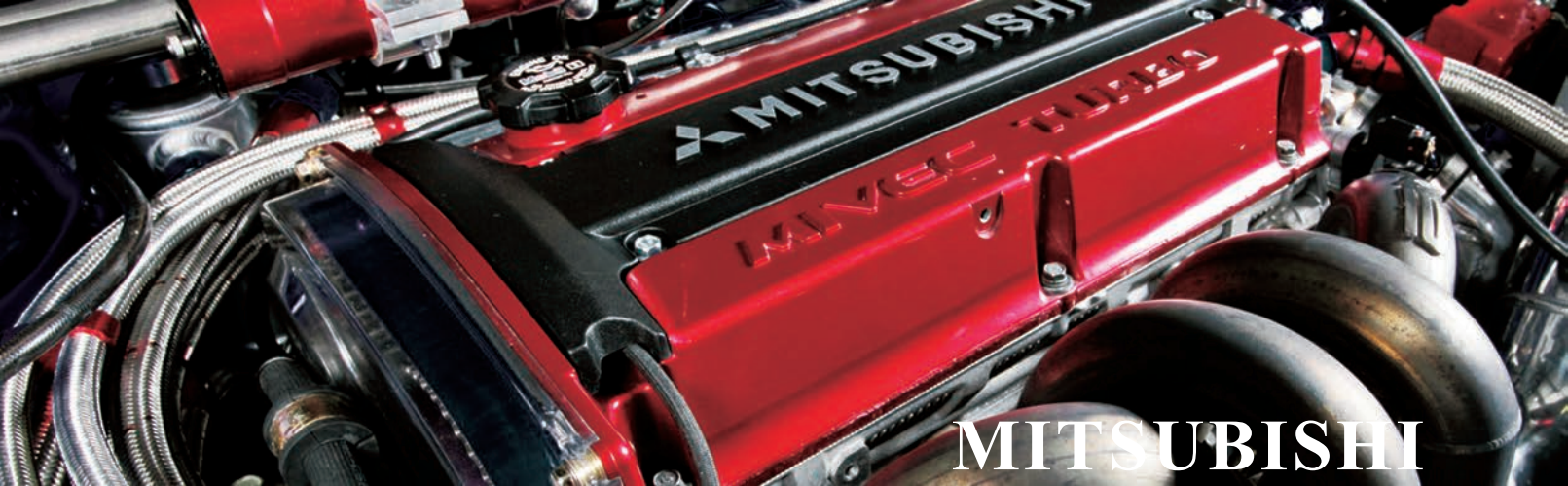

MITSUBISHI

SPECIFICATION

MITSUBISHI

Metal Head Gasket For 4G63

EVO 4~9 CP9A,CT9A

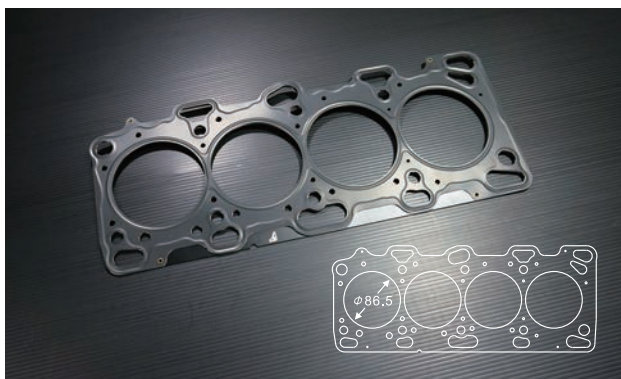

Thickness	Bore	Part No.	Type
1.00mm	86.50mm	CH081740-RB3	STOPPER
1.20mm	86.50mm	CH081740-RB2	
1.50mm	86.50mm	CH081740-RB1	
1.80mm	86.50mm	CH081740-RB0	

Metal Head Gasket For 4G63

EVO 1~3 CD9A,CE9A

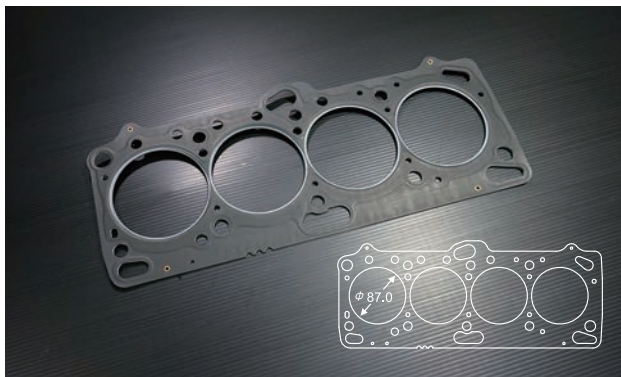

Thickness	Bore	Part No.	Type
1.30mm	87.00mm	CH081870-RB0	GROMMET
1.70mm	87.00mm	CH081870-RB1	

Metal Head Gasket For 4G63T

EVO 4~9 CP9A,CT9A

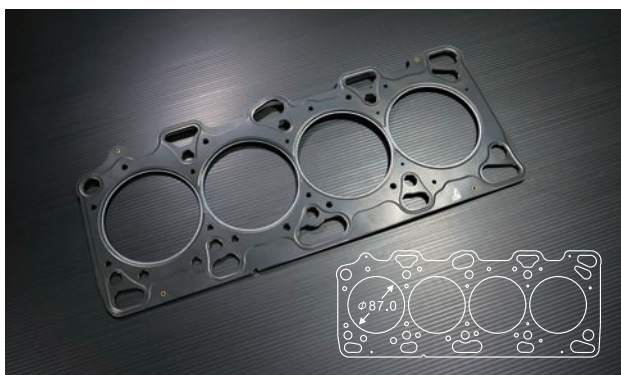

Thickness	Bore	Part No.	Type
0.90mm	87.00mm	CH081520-RA0	GROMMET
1.10mm	87.00mm	CH081520-RA1	
1.30mm	87.00mm	CH081520-RA2	
1.40mm	87.00mm	CH081520-RA3	
1.60mm	87.00mm	CH081520-RA4	
1.70mm	87.00mm	CH081520-RA5	

Metal Head Gasket For 4G93

LANCER MIRAGE SOHC,DOHC MPI GDI 1.8

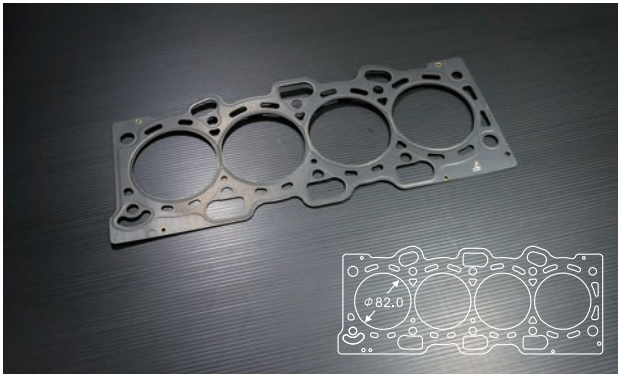

Thickness	Bore	Part No.	Type
0.60mm	82.00mm	CH080050-RC0	STOPPER
1.10mm	82.00mm	CH080050-RC6	
2.15mm	82.00mm	CH080050-RC1	

Metal Head Gasket For 4G93

LANCER MIRAGE SOHC,DOHC MPI GDI 1.8

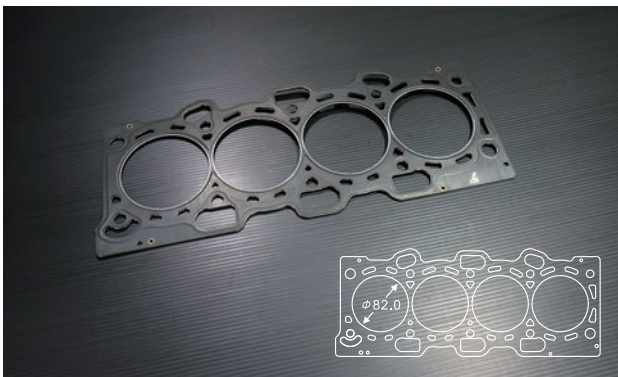

Thickness	Bore	Part No.	Type
1.10mm	82.00mm	CH081700-RA0	GROMMET
1.40mm	82.00mm	CH081700-RA1	
1.60mm	82.00mm	CH081700-RA2	
1.90mm	82.00mm	CH081700-RA3	
2.10mm	82.00mm	CH081700-RA4	

Metal Head Gasket For 4B11

EVO 2007~CZ4A

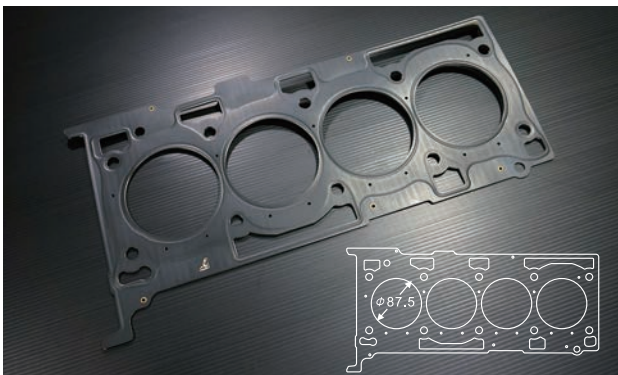

Thickness	Bore	Part No.	Type
1.15mm	87.50mm	CH081760-RD0	STOPPER
1.35mm	87.50mm	CH081760-RD1	
1.65mm	87.50mm	CH081760-RD2	

Exhaust Manifold Gasket For 4G63T

EVO 4~9

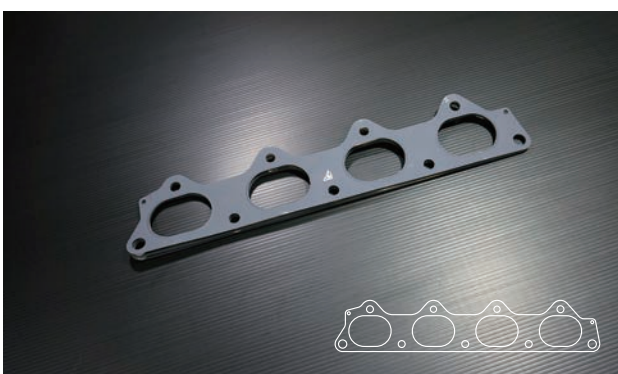

Thickness	Bore	Part No.	Type
0.80mm	N/A	EX080040-RE0	BEAD

Exhaust Manifold Gasket For 4G93

LANCER MIRAGE

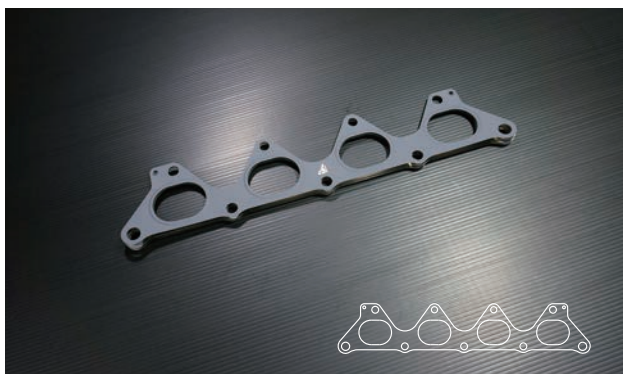

Thickness	Bore	Part No.	Type
0.60mm	N/A	EX080050-RC0	BEAD
1.20mm	N/A	EX080050-RE0	

Exhaust Manifold Gasket For 4B10 / 4B11 / 4B12

LANCER



Thickness	Bore	Part No.	Type
0.40mm	N/A	EX081570-RC0	BEAD

Intake Manifold Gasket For 4G63T

EVO 4~9

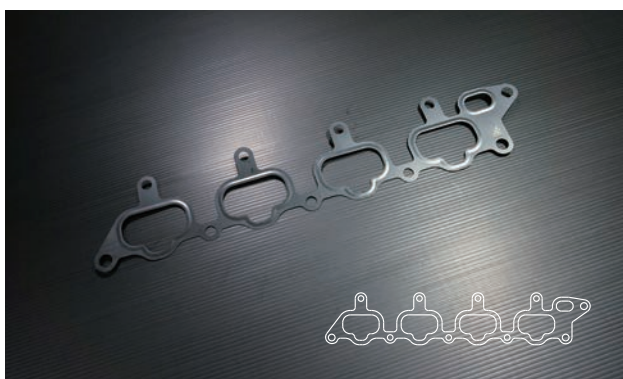

Thickness	Bore	Part No.	Type
0.30mm	N/A	IN081440-RC0	BEAD

Turbo Gasket For 4G63T

EVO 9~10



Thickness	Bore	Part No.	Type
2.50mm	N/A	TB081520-RA0	GROMMET

Turbo Gasket For 4G63T / 4B11

EVO 10

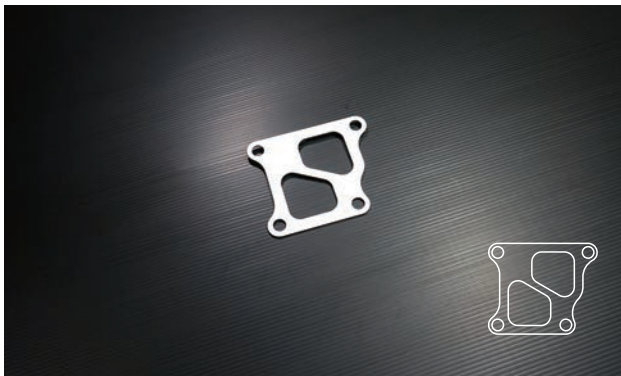

Thickness

Bore

Part No.

Type

2.50mm

N/A

TB081521-RA0

GROMMET

Full Set For 4G63T(EVO)

PELICA ,ECLIPSE I~II ,GALANT ,LANCER EVO

Part No.

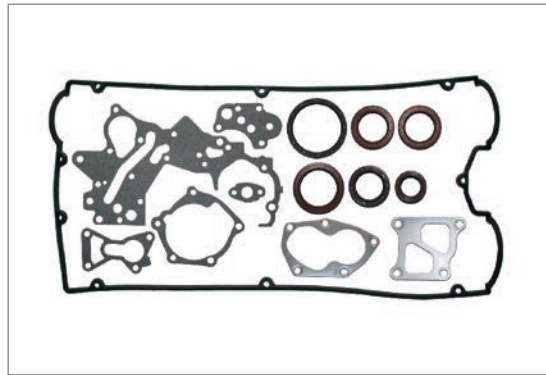
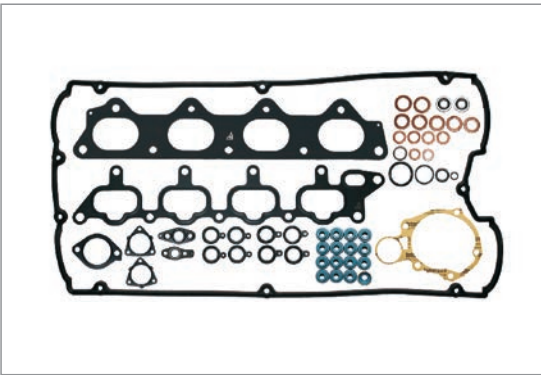

FS081520-RZ0

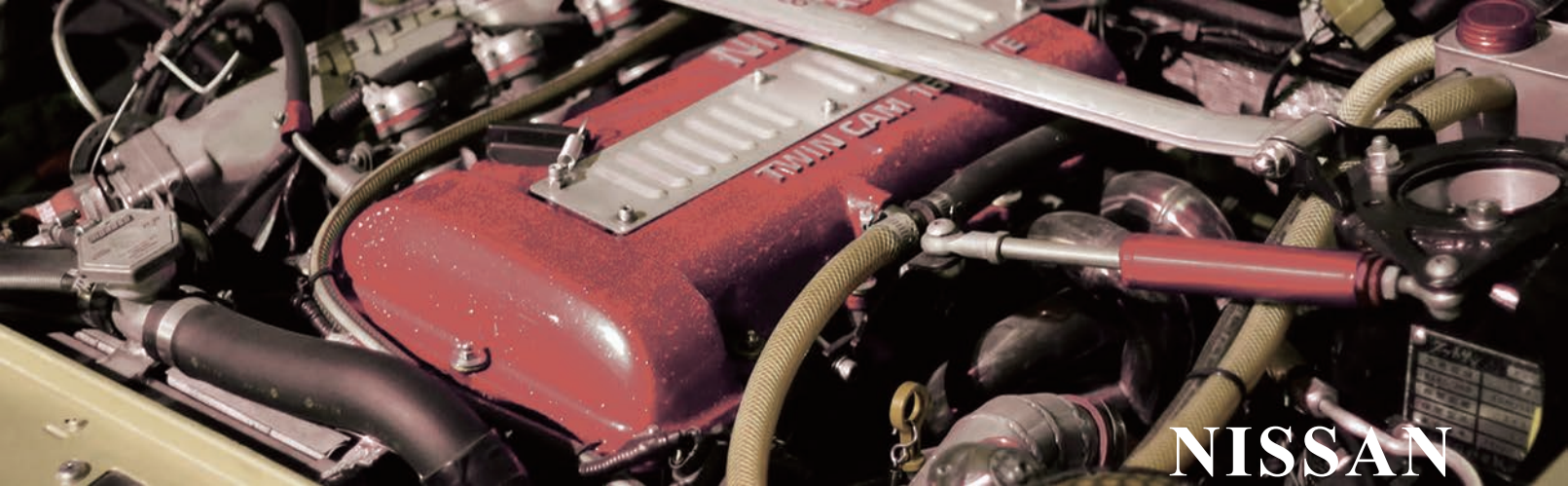

SPECIFICATION

NISSAN

Metal Head Gasket For CA18DET

SILVIA S12/180SX/S13



Thickness	Bore	Part No.	Type
1.20mm	85.00mm	CH092140-RC0	STOPPER
1.50mm	85.00mm	CH092140-RC1	

Metal Head Gasket For SR20DET

SILVIA S14/S15/200SX



Thickness	Bore	Part No.	Type
1.15mm	87.00mm	CH091660-RB1	STOPPER
1.35mm	87.00mm	CH091660-RB2	
1.65mm	87.00mm	CH091660-RB3	
1.95mm	87.00mm	CH091660-RB4	

Metal Head Gasket For SR20DET

SILVIA S14/S15/200SX



Thickness	Bore	Part No.	Type
1.15mm	88.00mm	CH091670-RB1	STOPPER
1.35mm	88.00mm	CH091670-RB2	
1.65mm	88.00mm	CH091670-RB3	
1.75mm	88.00mm	CH091670-RB5	
1.95mm	88.00mm	CH091670-RB4	

Metal Head Gasket For SR20DET

SILVIA S14/S15/200SX



Thickness	Bore	Part No.	Type
1.20mm	87.00mm	CH090620-RC4	GROMMET
1.30mm	87.00mm	CH090620-RC1	
1.60mm	87.00mm	CH090620-RC2	
1.90mm	87.00mm	CH090620-RC3	

Metal Head Gasket For SR20DET

SILVIA S14/S15/200SX



Thickness	Bore	Part No.	Type
1.15mm	88.00mm	CH090620-RD1	STOPPER
1.55mm	88.00mm	CH090620-RD2	
1.95mm	88.00mm	CH090620-RD3	

Metal Head Gasket For SR20DET

SILVIA S14/S15/200SX



Thickness	Bore	Part No.	Type
1.30mm	88.00mm	CH090620-RE1	GROMMET
1.60mm	88.00mm	CH090620-RE2	
1.90mm	88.00mm	CH090620-RE3	

Metal Head Gasket For SR20DET

SILVIA S14/S15/200SX

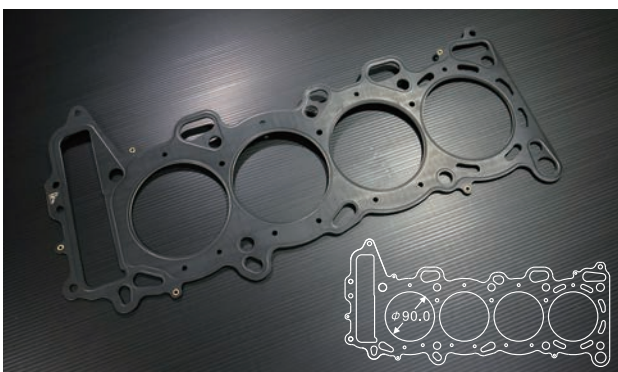

Thickness	Bore	Part No.	Type
1.30mm	90.00mm	CH092080-RA0	STOPPER
1.50mm	90.00mm	CH092080-RA1	
1.80mm	90.00mm	CH092080-RA2	

Metal Head Gasket For SR20DET

SILVIA S14/S15/200SX



Thickness	Bore	Part No.	Type
1.95mm	89.00mm	CH092340-RA4	STOPPER

Metal Head Gasket For KA24

SILVIA 240SX

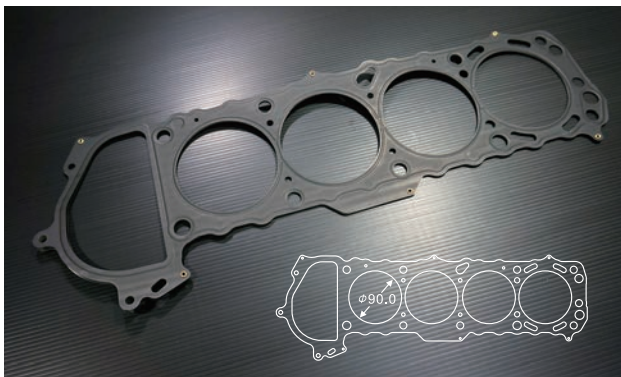

Thickness	Bore	Part No.	Type
0.70mm	90.00mm	CH091700-RC1	STOPPER
1.00mm	90.00mm	CH091700-RC0	
1.10mm	90.00mm	CH091700-RC2	
1.30mm	90.00mm	CH091700-RC3	
1.60mm	90.00mm	CH091700-RC4	

Metal Head Gasket For QR20DE / QR25DE

PRIMERA, MAXIMA 2.0/2.5

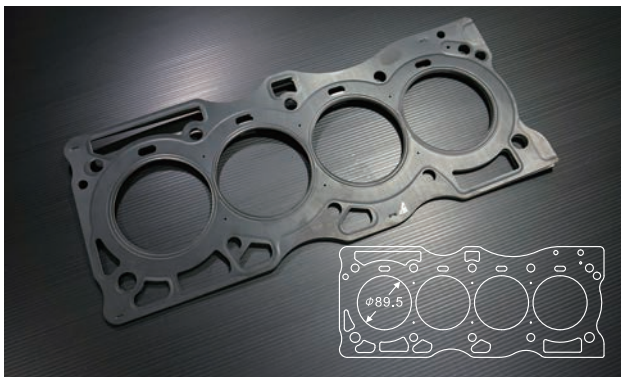

Thickness	Bore	Part No.	Type
1.65mm	89.50mm	CH091100-RD1	STOPPER

Metal Head Gasket For RB25DET

SKYLINE GTS R32/25GT(ER34)

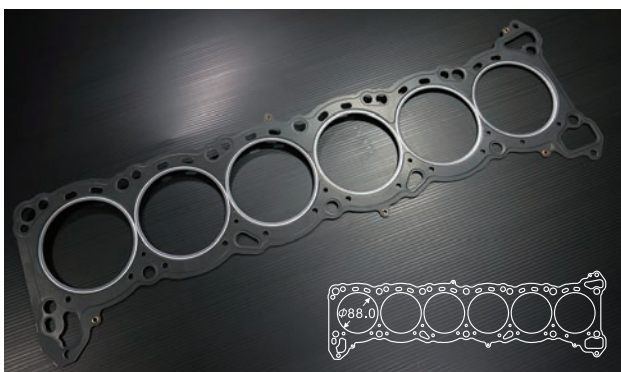

Thickness	Bore	Part No.	Type
1.30mm	88.00mm	CH091090-RA0	GROMMET
1.60mm	88.00mm	CH091090-RA1	
1.90mm	88.00mm	CH091090-RA2	
2.50mm	88.00mm	CH091090-RA3	

Metal Head Gasket For RB25DET

SKYLINE GTS R32/25GT(ER34)

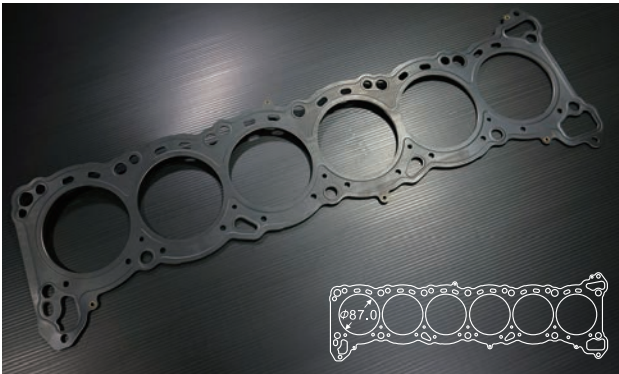

Thickness	Bore	Part No.	Type
1.20mm	87.00mm	CH092120-RC0	GROMMET
1.50mm	87.00mm	CH092120-RC1	
1.80mm	87.00mm	CH092120-RC2	
2.50mm	87.00mm	CH092120-RC3	

Metal Head Gasket For RB20DET

SKYLINE R31

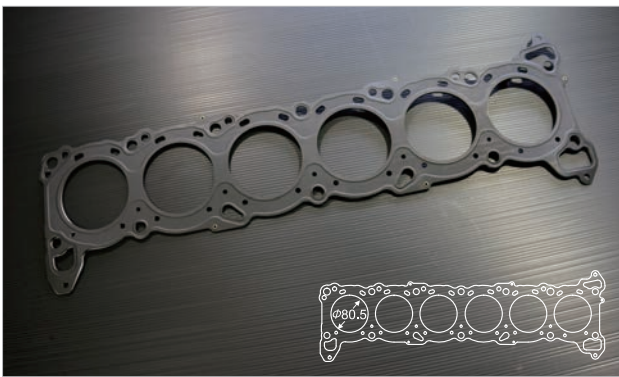

Thickness	Bore	Part No.	Type
1.20mm	80.50mm	CH092130-RC0	GROMMET
1.50mm	80.50mm	CH092130-RC1	
1.80mm	80.50mm	CH092130-RC2	

Metal Head Gasket For RB26DETT

SKYLINE GT-R R32/R33/R34



Thickness	Bore	Part No.	Type
1.30mm	88.00mm	CH090670-RA0	GROMMET
1.60mm	88.00mm	CH090670-RA1	
1.90mm	88.00mm	CH090670-RA2	

Metal Head Gasket For RB26DETT

SKYLINE GT-R R32/R33/R34

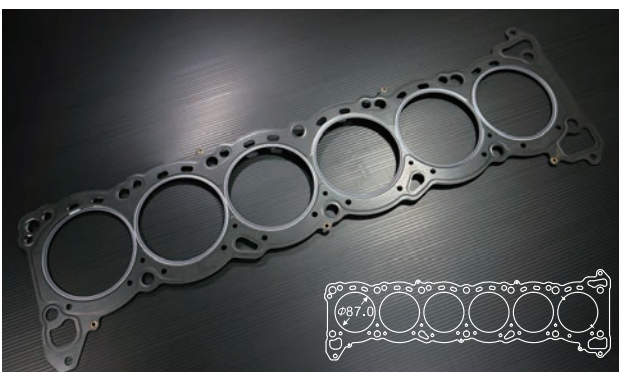

Thickness	Bore	Part No.	Type
1.20mm	87.00mm	CH091850-RE1	GROMMET
1.50mm	87.00mm	CH091850-RE0	
1.80mm	87.00mm	CH091850-RE2	

Metal Head Gasket For RB26DETT

SKYLINE GT-R 1989-2002

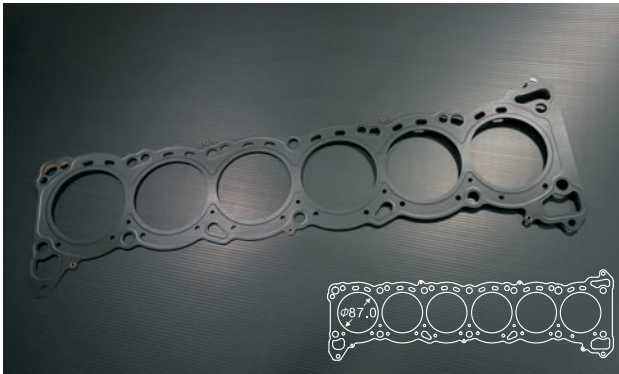

Thickness	Bore	Part No.	Type
0.85mm	87.00mm	CH091850-RI3	STOPPER

Metal Head Gasket For RB26DETT

SKYLINE GT-R R32/R33/R34

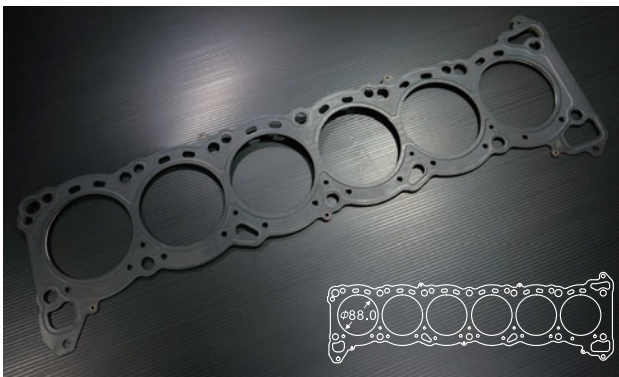

Thickness	Bore	Part No.	Type
1.20mm	88.00mm	CH091900-RD1	GROMMET
1.50mm	88.00mm	CH091900-RD0	
1.80mm	88.00mm	CH091900-RD2	

Metal Head Gasket For TB48DE

PATROL GR V 4.8 2000~

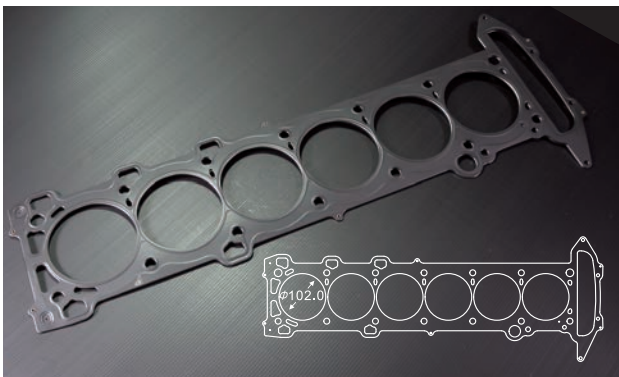

Thickness	Bore	Part No.	Type
1.20mm	102.00mm	CH092540-RB1	STOPPER
1.50mm	102.00mm	CH092540-RB0	
1.60mm	102.00mm	CH092540-RB2	
2.00mm	102.00mm	CH092540-RB3	

Metal Head Gasket For VG30DETT

FAIRLADY Z 300ZX(Z32)



Thickness	Bore	Part No.	Type
1.20mm	89.00mm	CH092110-RE0	GROMMET
1.50mm	89.00mm	CH092110-RE1	

Metal Head Gasket For VQ35DE -L

FAIRLADY Z 350ZX(Z33)



Thickness	Bore	Part No.	Type
0.70mm	96.00mm	CH092150-RC0	STOPPER
1.00mm	96.00mm	CH092150-RC1	

Metal Head Gasket For VQ35DE -R

FAIRLADY Z 350ZX(Z33)



Thickness	Bore	Part No.	Type
0.70mm	96.00mm	CH092160-RC0	STOPPER
1.00mm	96.00mm	CH092160-RC1	

Metal Head Gasket For VK56VD(LH)

INFINITI QX56 2010~2014 ,INFINITI QX80 2013~

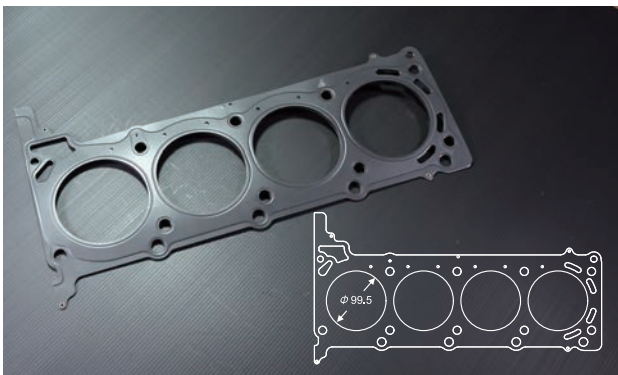

Thickness	Bore	Part No.	Type
0.90mm	99.50mm	CH092510-RB0(L)	STOPPER

Metal Head Gasket For VK56VD(RH)

INFINITI QX56 2010~2014 ,INFINITI QX80 2013~



Thickness	Bore	Part No.	Type
0.90mm	99.50mm	CH092520-RB0(R)	STOPPER

Metal Head Gasket For VR38DETT -L

SKYLINE GT-R R35 2010~



Thickness	Bore	Part No.	Type
0.80mm	96.00mm	CH091690-RB0(L)	STOPPER
1.00mm	96.00mm	CH091690-RB1(L)	

Metal Head Gasket For VR38DETT -R

SKYLINE GT-R R35 2010~



Thickness	Bore	Part No.	Type
0.80mm	96.00mm	CH091760-RB0(R)	STOPPER
1.00mm	96.00mm	CH091760-RB1(R)	

Metal Head Gasket For VR38DETT -L

SKYLINE GT-R R35 2010~



Thickness	Bore	Part No.	Type
0.80mm	100.00mm	CH092050-RC1(L)	STOPPER
1.00mm	100.00mm	CH092050-RC0(L)	

Metal Head Gasket For VR38DETT -R

SKYLINE GT-R R35 2010~



Thickness	Bore	Part No.	Type
0.80mm	100.00mm	CH092060-RC1(R)	STOPPER
1.00mm	100.00mm	CH092060-RC0(R)	

Exhaust Manifold Gasket For SR20DET

SILVIA S13/S14/S15



Thickness	Bore	Part No.	Type
1.40mm	N/A	EX090621-RE0	BEAD

Exhaust Manifold Gasket For SR20DET

SILVIA S13/S14/S15



Thickness	Bore	Part No.	Type
1.40mm	N/A	EX090622-RA0	BEAD

Exhaust Manifold Gasket For RB25DET

SKYLINE 25GT ER34



Thickness	Bore	Part No.	Type
0.75mm	N/A	EX091090-RA0	BEAD

Exhaust Manifold Gasket For RB26DETT

SKYLINE GT-R R32/R33/R34



Thickness	Bore	Part No.	Type
1.20mm	N/A	EX090670-RD0	BEAD

Exhaust Manifold Gasket For VR38DETT

SKYLINE GT-R R35



Thickness	Bore	Part No.	Type
0.80mm	34x49 mm	EX091580-RA0	BEAD

Intake Manifold Gasket For SR20DET

SILVIA S13



Thickness	Bore	Part No.	Type
0.45mm	N/A	IN090620-RC0	BEAD

Intake Manifold Gasket For SR20DET

SILVIA S14/S15



Thickness	Bore	Part No.	Type
0.35mm	N/A	IN090621-RD0	BEAD

Intake Manifold Gasket For SR20DI

SILVIA



Thickness	Bore	Part No.	Type
0.35mm	N/A	IN090622-RD0	BEAD

Intake Manifold Gasket For RB25DET

SKYLINE GT-R R32/R33/R34



Thickness	Bore	Part No.	Type
1.20mm	N/A	IN091090-R00	BEAD

Intake Manifold Gasket For RB26DETT

SKYLINE GT-R R32/R33/R34



Thickness	Bore	Part No.	Type
0.35mm	N/A	IN090670-RD0	BEAD

Intake Collector Gasket For SR20DET

SILVIA



Thickness	Bore	Part No.	Type
0.35mm	N/A	UN090620-RA0	BEAD

Intake Collector Gasket For SR20DET

SILVIA



Thickness	Bore	Part No.	Type
0.35mm	N/A	UN090621-RA0	BEAD

Turbo Gasket For FE6T

GFE6 / FE6T / FD6 / FD6T

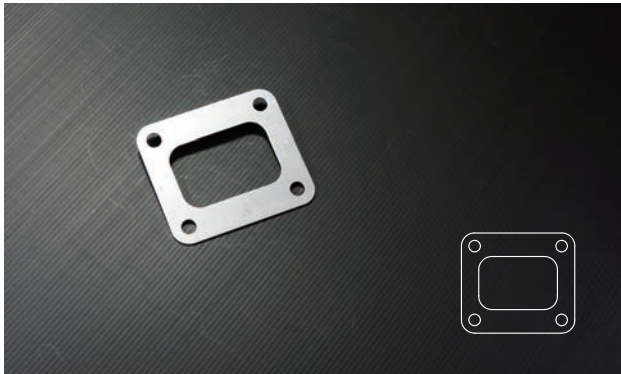

Thickness	Bore	Part No.	Type
1.50mm	N/A	TB090220-RA0	BEAD

Turbo Gasket For SR20DET

GARRETT T25 AR60

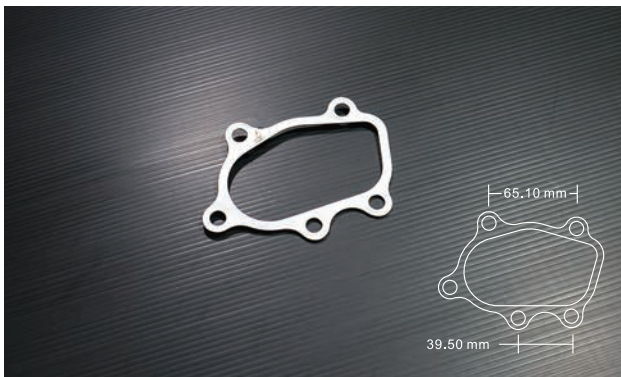

Thickness	Bore	Part No.	Type
1.90mm	N/A	TB090620-RC0	GROMMET

Turbo Gasket For SR20DET

GARRETT T25 AR60



Thickness	Bore	Part No.	Type
1.90mm	N/A	TB090621-RB0	GROMMET

Turbo Gasket For SR20DET / VE

200SX 2.0 1993~1999 ,SILVIA 2000 2000~2003



Thickness	Bore	Part No.	Type
0.50mm	N/A	TB092570-RA0	BEAD

Turbo Gasket For VD30DTT / VG30DTT

FAIRLADY 300ZX



Thickness	Bore	Part No.	Type
1.60mm	N/A	TB091610-RA0	GROMMET

Turbo Gasket For RB25DET

GT-R

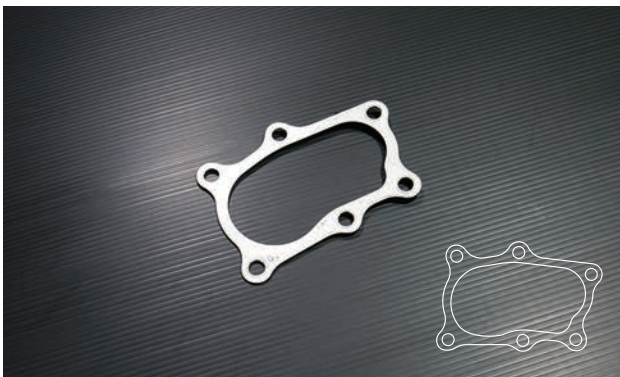

Thickness	Bore	Part No.	Type
1.60mm	N/A	TB091090-RB0	GROMMET

Turbo Gasket For RB26DETT

GT-R

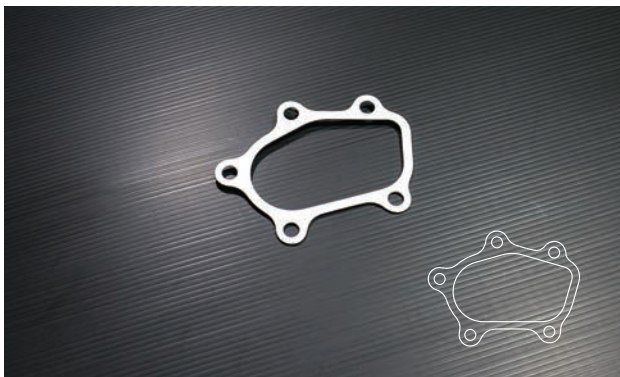

Thickness	Bore	Part No.	Type
1.90mm	N/A	TB090670-RA0	GROMMET

Turbo Pipe Gasket For SR20DET / RB26DETT / T28

GARRETT T25

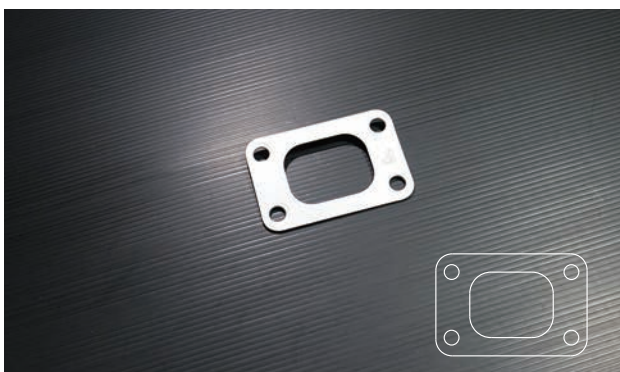

Thickness	Bore	Part No.	Type
1.90mm	N/A	PI090620-RD0	GROMMET

Turbo Pipe Gasket For RB25DET / RB20DET / T3

SKYLINE 25GT

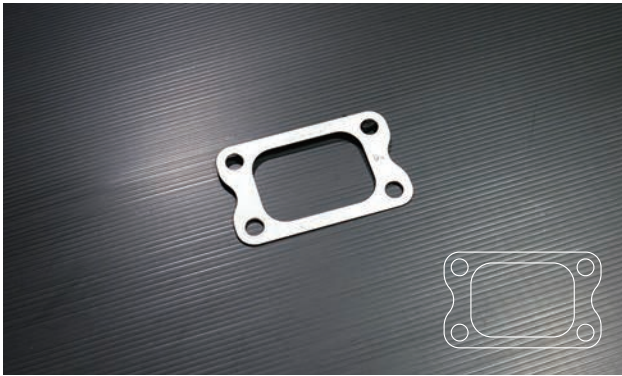

Thickness	Bore	Part No.	Type
1.60mm	N/A	PI091091-RA0	GROMMET

Throttle Chamber Gasket For RB26DETT

SKYLINE GT-R R32/R33/R34



Thickness	Bore	Part No.	Type
0.35mm	N/A	OT090670-RB0	BEAD

Throttle Chamber Gasket For SR20 / T28

300ZX 1990~1996



Thickness	Bore	Part No.	Type
0.75mm	8.60mm	OT092370-R00	N/A

Full Set For SR20DET

SILVIA 2000 ,200SX 2.0

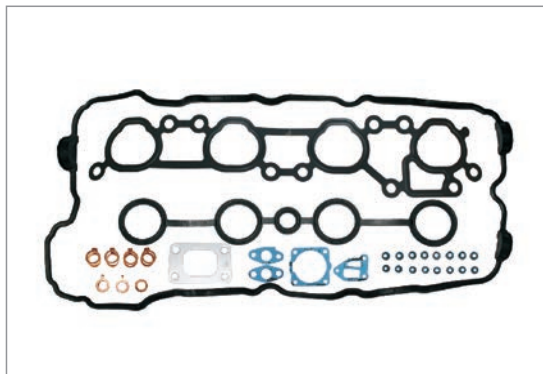
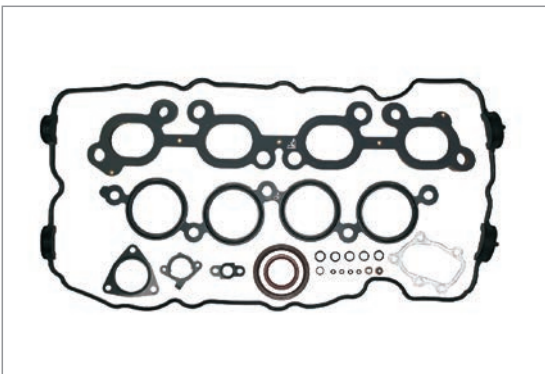

Part No.
FS090623-RDZ

Full Set For SR20DET

SILVIA 2000 ,200SX 2.0

Part No.

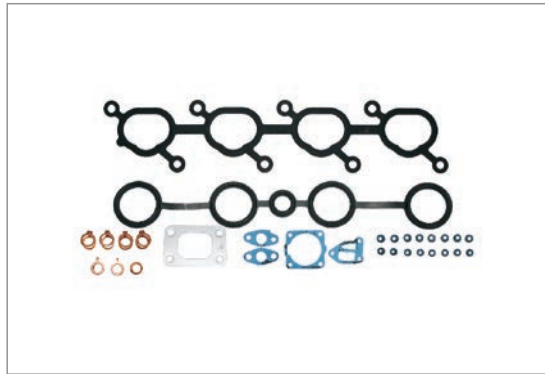

FS090623-RFZ

Full Set For SR20DET

SILVIA 2000 ,200SX 2.0

Part No.

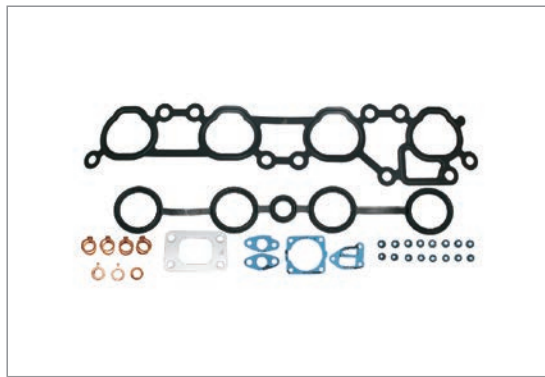
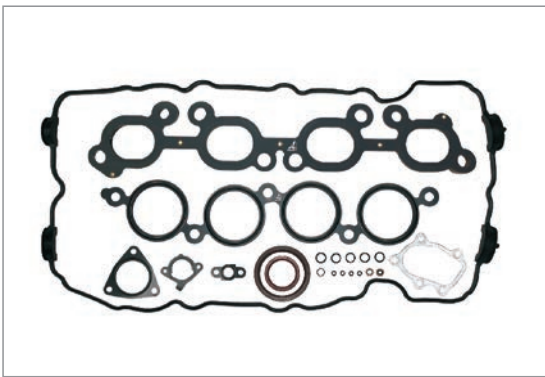

FS090623-RGZ

Full Set For RB25DET

SKYLINE GTS R32~R34 ,CEDRIC X ,STAGEA 2.5

Part No.

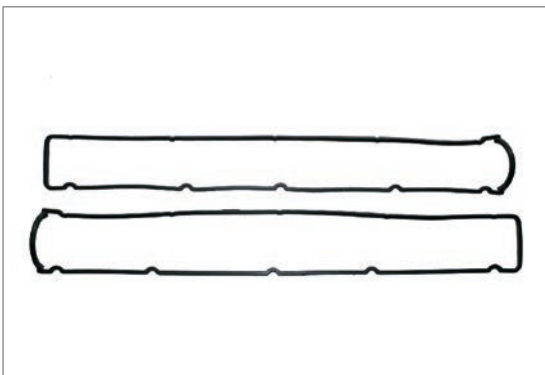

FS091090-RZ0

Full Set For RB26DETT

SKYLINE GT-R R32~R34

Part No.

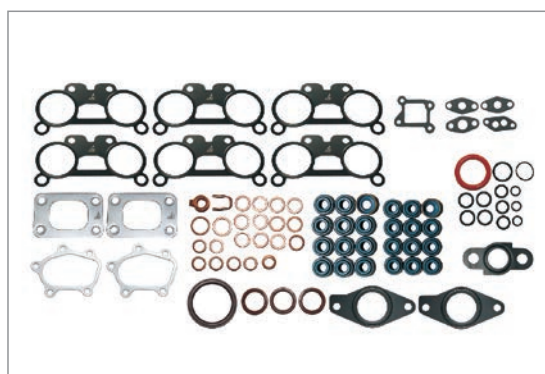
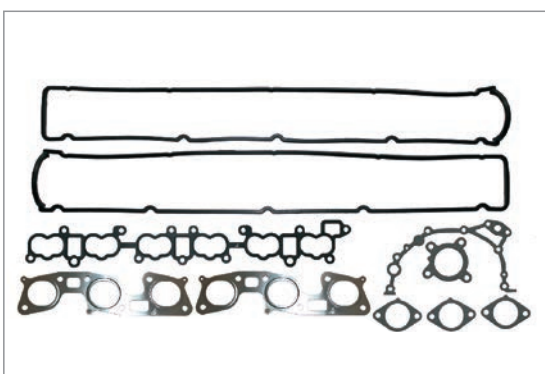

FS090670-RZC



SPECIFICATION

PRINCE

Metal Head Gasket For EP3/ R56

MINI COPPER S EP3/R56 N12B16A

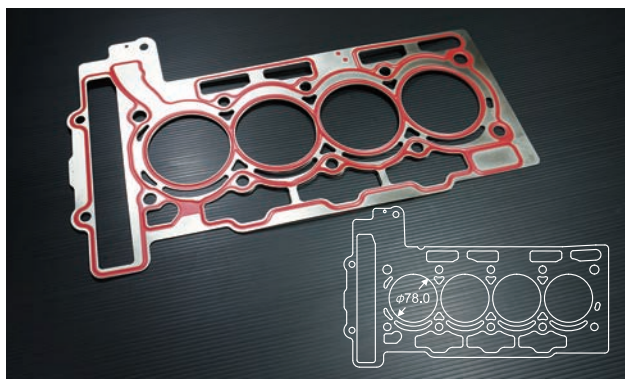

Thickness	Bore	Part No.	Type
0.65mm	78.00mm	CH270070-RD0	STOPPER

Metal Head Gasket For EP6/ R56

MINI COPPER S 1.6T EP6/R56 N14B16A

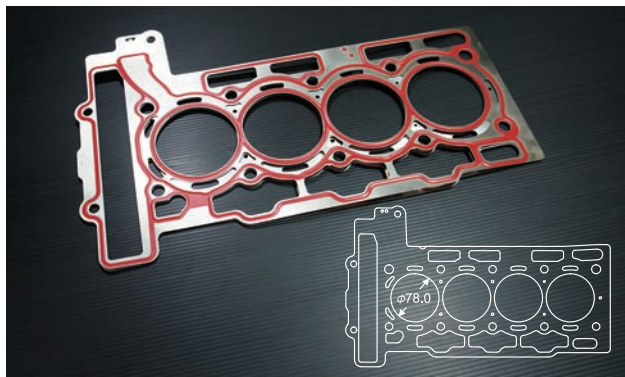

Thickness	Bore	Part No.	Type
0.90mm	78.00mm	CH270080-RE0	STOPPER
1.20mm	78.00mm	CH270080-RE1	
1.50mm	78.00mm	CH270080-RE3	

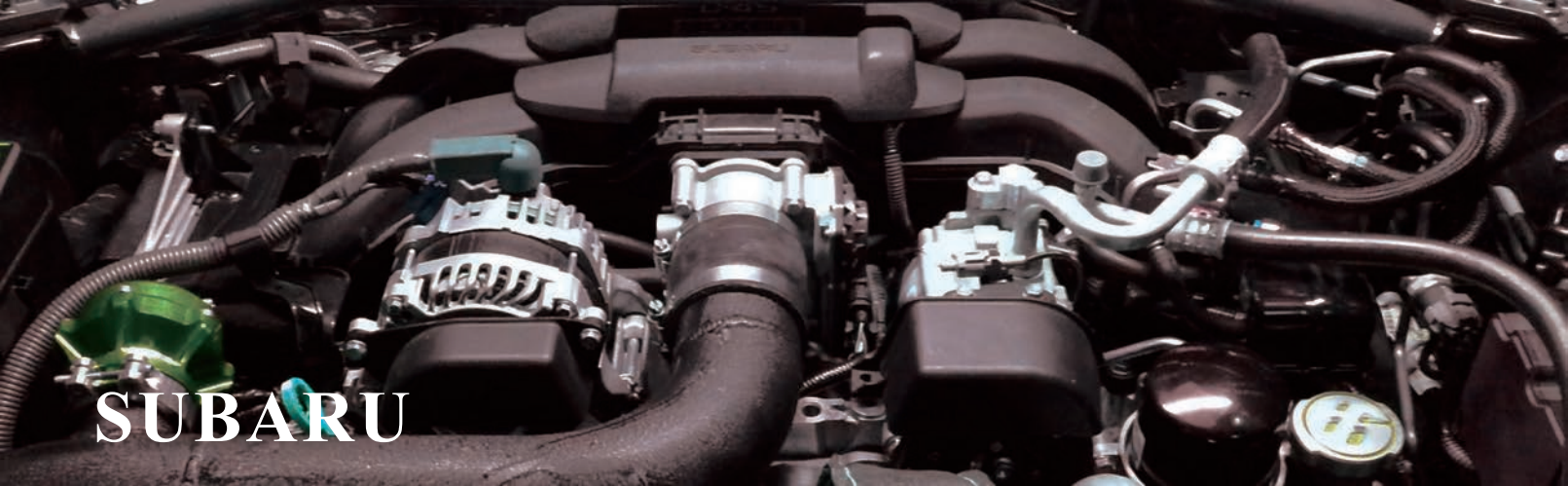

SPECIFICATION

SUBARU

Metal Head Gasket For EJ20

IMPREZA WRX STI (GC8V)

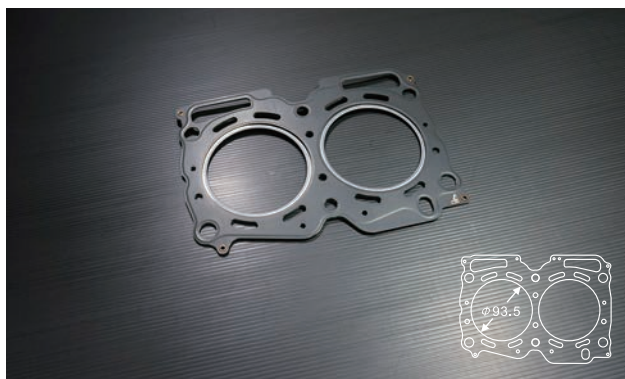

Thickness	Bore	Part No.	Type
1.10mm	93.50mm	CH230330-RA1	GROMMET
1.30mm	93.50mm	CH230330-RA2	
1.60mm	93.50mm	CH230330-RA3	

Metal Head Gasket For EJ20

IMPREZA WRX STI (GC8V)

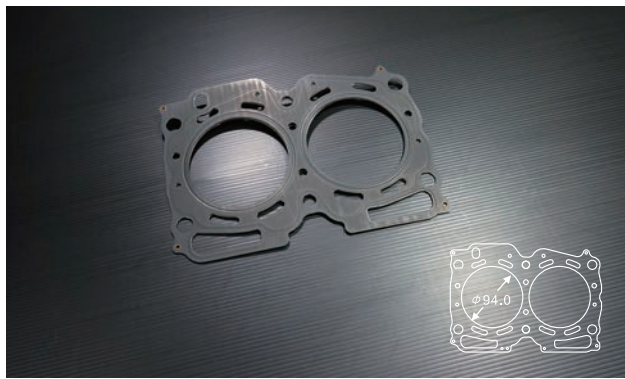

Thickness	Bore	Part No.	Type
0.70mm	94.00mm	CH230610-RC0	STOPPER
1.00mm	94.00mm	CH230610-RC1	
1.20mm	94.00mm	CH230610-RC2	
1.50mm	94.00mm	CH230610-RC3	

Metal Head Gasket For EJ25

IMPREZA WRX RS T/B 2.5L

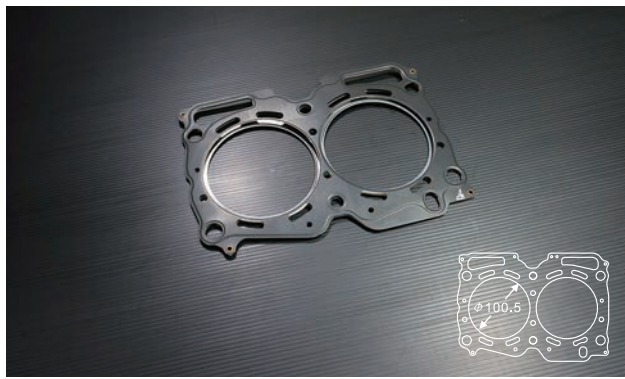

Thickness	Bore	Part No.	Type
0.90mm	100.50mm	CH230360-RA0	GROMMET
1.10mm	100.50mm	CH230360-RA1	
1.40mm	100.50mm	CH230360-RA2	
1.60mm	100.50mm	CH230360-RA3	

Metal Head Gasket For EJ25

IMPREZA WRX RS T/B 2.5L



Thickness	Bore	Part No.	Type
0.90mm	101.00mm	CH230340-RA1	GROMMET
1.10mm	101.00mm	CH230340-RA2	
1.40mm	101.00mm	CH230340-RA3	
1.60mm	101.00mm	CH230340-RA4	

Metal Head Gasket For EJ25

IMPREZA FORESTER 2.5



Thickness	Bore	Part No.	Type
1.10mm	101.00mm	CH230340-RJ2	GROMMET
1.40mm	101.00mm	CH230340-RJ3	
1.60mm	101.00mm	CH230340-RJ4	

Metal Head Gasket For EJ25

IMPREZA WRX RS T/B 2.5L



Thickness	Bore	Part No.	Type
1.10mm	101.00mm	CH230340-RR2	GROMMET
1.40mm	101.00mm	CH230340-RR3	

Metal Head Gasket For EJ25(GDB)

IMPREZA 9 2.5L(GDB) ~2007



Thickness	Bore	Part No.	Type
0.80mm	101.00mm	CH230390-RB0	STOPPER
1.10mm	101.00mm	CH230390-RB1	
1.30mm	101.00mm	CH230390-RB2	
1.60mm	101.00mm	CH230390-RB3	

Metal Head Gasket For EJ255 / EJ257 (GRB)

IMPREZA 10 2.5L(GRB) 2008~

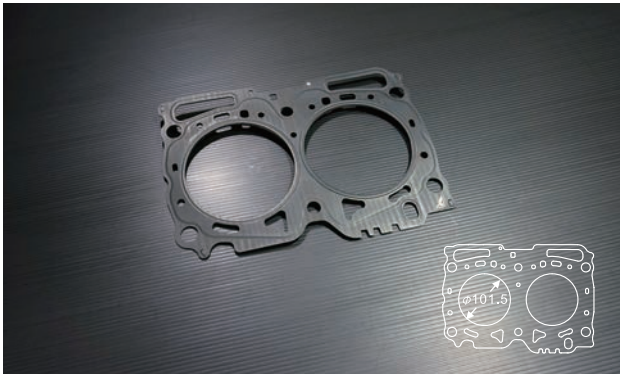

Thickness	Bore	Part No.	Type
0.80mm	101.50mm	CH230240-RG0	STOPPER

Metal Head Gasket For EJ255 / EJ257 (GRB)

IMPREZA 10 2.5L(GRB) 2008~



Thickness	Bore	Part No.	Type
1.10mm	101.00mm	CH230240-RL1	GROMMET
1.40mm	101.00mm	CH230240-RL2	

Metal Head Gasket For FA20 - L

BRZ, FR-S, GT-86(4U-GSE)



Thickness	Bore	Part No.	Type
0.80mm	89.50mm	CH230520-RA0 (L)	STOPPER
1.00mm	89.50mm	CH230520-RA1 (L)	
1.20mm	89.50mm	CH230520-RA2 (L)	
1.40mm	89.50mm	CH230520-RA3 (L)	

Metal Head Gasket For FA20 - R

BRZ, FR-S, GT86(4U-GSE)



Thickness	Bore	Part No.	Type
0.80mm	89.50mm	CH230530-RA0 (R)	STOPPER
1.00mm	89.50mm	CH230530-RA1 (R)	
1.20mm	89.50mm	CH230530-RA2 (R)	
1.40mm	89.50mm	CH230530-RA3 (R)	

Exhaust Manifold Gasket For EJ18 / EJ20 / EJ25

IMPREZA



Thickness	Bore	Part No.	Type
1.20mm	46.50mm	EX230110-RD0	GROMMET

Exhaust Manifold Gasket For FA20 / FB20

BRZ, FR-S, GT86



Thickness	Bore	Part No.	Type
1.15mm	46.50mm	EX230520-RA0	GROMMET

Intake Manifold Gasket For EJ255

IMPREZA



Thickness	Bore	Part No.	Type
1.00mm	N/A	IN230240-RA0	BEAD

Intake Collector Gasket For EJ255

IMPREZA



Thickness	Bore	Part No.	Type
0.35mm	54.00mm	UN230240-RB0	BEAD

Intake Collector Gasket For EJ253

IMPREZA



Thickness	Bore	Part No.	Type
0.35mm	54.00mm	UN230270-RB0	BEAD

Turbo Gasket For EJ255 / EJ257

IMPREZA



Thickness	Bore	Part No.	Type
0.80mm	62.50mm	TB230240-RA0	GROMMET

Turbo Gasket For EJ255 / EJ257

IMPREZA



Thickness	Bore	Part No.	Type
0.80mm	N/A	TB230241-RA0	GROMMET

Turbo Gasket For EJ207

WRX / STI 1998~



Thickness	Bore	Part No.	Type
0.80mm	N/A	TB230350-RD0	GROMMET

Turbo Gasket For EJ207

WRX / STI 1998~

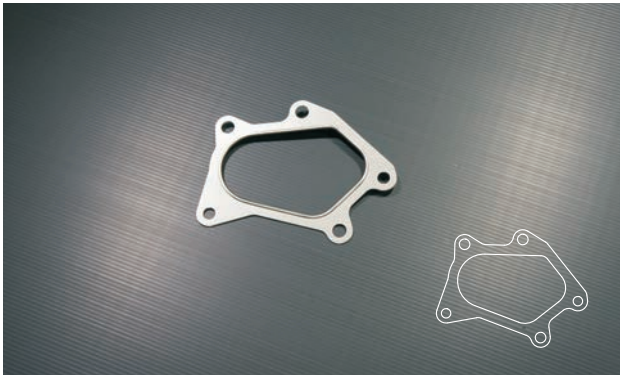

Thickness	Bore	Part No.	Type
0.80mm	N/A	TB230351-RD0	GROMMET

Turbo Gasket For EJ207

WRX / STI 1998~



Thickness	Bore	Part No.	Type
0.80mm	N/A	TB230352-RC0	GROMMET

Turbo Pipe Gasket For FA20

BRZ, FR-S, GT86(4U-GSE)



Thickness	Bore	Part No.	Type
0.90mm	42.50mm	TB230520-RB0	GROMMET

Turbo Pipe Gasket For EJ255 / EJ257

IMPREZA



Thickness	Bore	Part No.	Type
1.60mm	48.50mm	PI230240-RA0	GROMMET

Turbo Pipe Gasket For EJ25

IMPREZA



Thickness	Bore	Part No.	Type
1.40mm	57.00mm	PI230300-RA0	GROMMET

Turbo Pipe Gasket For FA20

BRZ, FR-S, GT86(4U-GSE)



Thickness	Bore	Part No.	Type
0.65mm	88.00mm	PI230520-RB0	GROMMET

Full Set For FA20(NA)

GT86 2.0 BRZ 2.0 ,FR-S

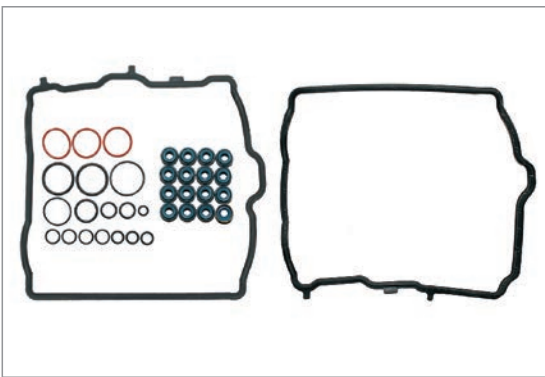

Part No.
FS230520-RZA

Full Set For EJ20(GRB 2.0)

IMPREZA ,WRX STI ,LEGACY OUTBACK

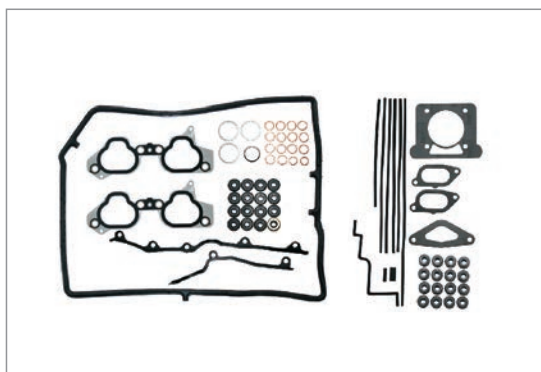

Part No.
FS0230820-RZ0

Full Set For EJ20(GRB 2.0)

IMPREZA 2.0 ,LEGACY I~II 2.0 ,WRX STI

Part No.

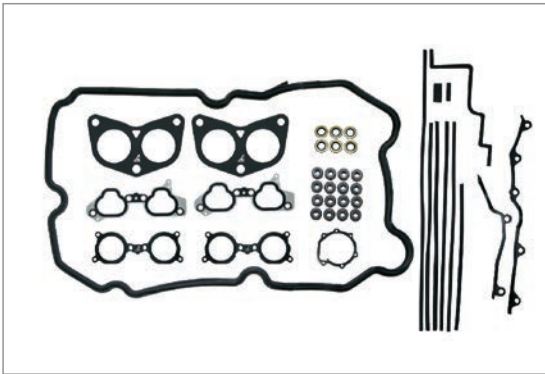
FS230830-RZ0

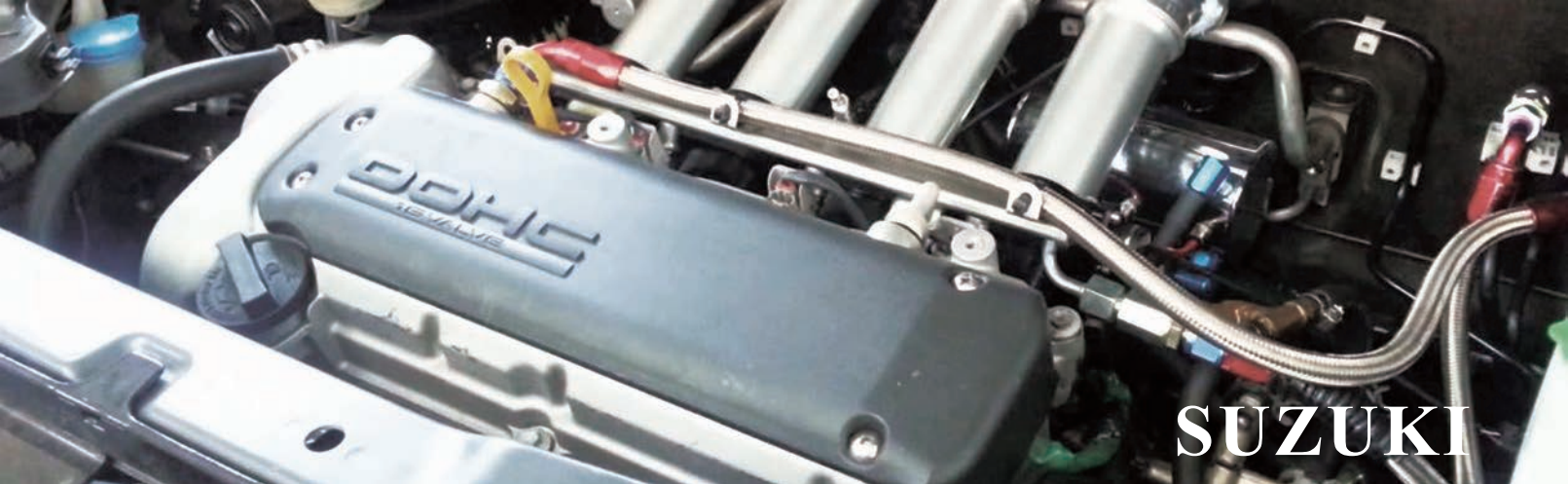

SPECIFICATION

SUZUKI

Metal Head Gasket For M13A / M15A

SWIFT 1.5 M15A, SX4 1.6 M16A



Thickness	Bore	Part No.	Type
0.55mm	79.00mm	CH150010-RD4	STOPPER
0.80mm	79.00mm	CH150010-RD0	
1.20mm	79.00mm	CH150010-RD1	
1.40mm	79.00mm	CH150010-RD2	
1.70mm	79.00mm	CH150010-RD3	
2.60mm	79.00mm	CH150010-RD5	

Exhaust Manifold Gasket For M15A

SWIFT 1.5L 2000~, IGNIS 2016~, SX4 2006~



Thickness	Bore	Part No.	Type
0.50mm	46.70mm	EX150010-RB0	BEAD

Intake Collector Gasket For M13A

IGNIS 2016~, JIMMY 1998~



Thickness	Bore	Part No.	Type
0.40mm	N/A	IN150011-RC0	BEAD

TOYOTA

SPECIFICATION

TOYOTA

Metal Head Gasket For 7A-FE

COROLLA AE102 / CROWN GS300

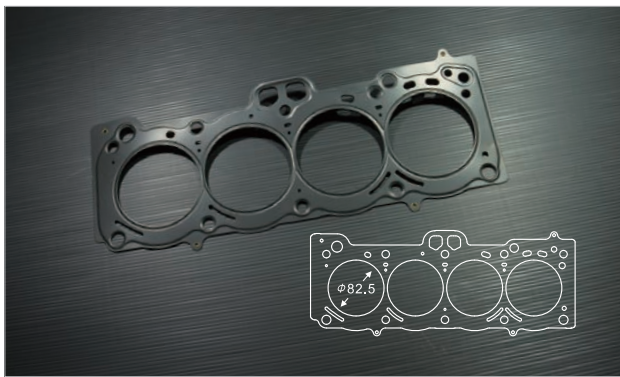

Thickness	Bore	Part No.	Type
1.35mm	82.50mm	CH110010-RE3	STOPPER
2.00mm	82.50mm	CH110010-RE1	

Metal Head Gasket For 1JZ-GTE

SUPRA 3 JZA70

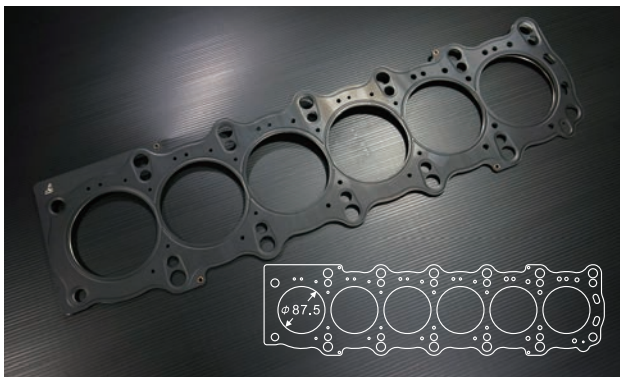

Thickness	Bore	Part No.	Type
1.50mm	87.50mm	CH111970-RB1	STOPPER
1.80mm	87.50mm	CH111970-RB0	
2.00mm	87.50mm	CH111970-RB2	

Metal Head Gasket For 2JZ-GTE

SUPRA 4 JZA80

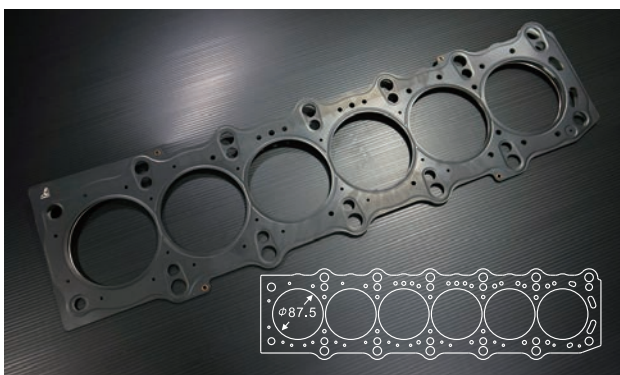

Thickness	Bore	Part No.	Type
1.30mm	87.50mm	CH111960-RB3	STOPPER
1.50mm	87.50mm	CH111960-RB1	
1.80mm	87.50mm	CH111960-RB0	
2.00mm	87.50mm	CH111960-RB2	

Metal Head Gasket For 2JZ-GTE

LEXUS-GU300 1997-2004

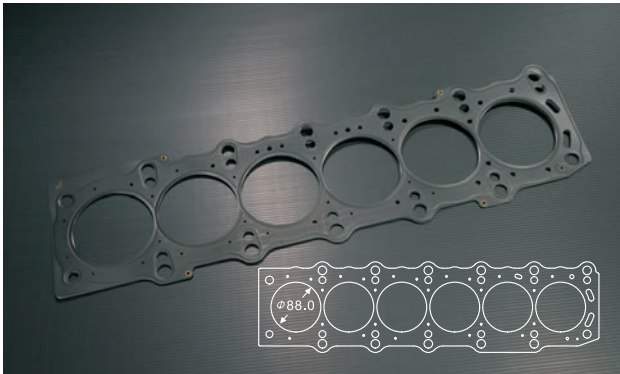

Thickness	Bore	Part No.	Type
1.00mm	88.00mm	CH112600-RA2	STOPPER
1.30mm	88.00mm	CH112600-RA0	
1.50mm	88.00mm	CH112600-RA1	

Metal Head Gasket For 2JZ-GE

GROWN GS300

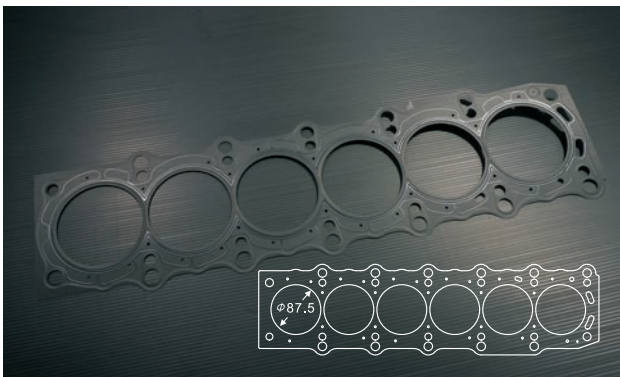

Thickness	Bore	Part No.	Type
0.55mm	87.50mm	CH110230-RE0	GROMENT

Metal Head Gasket For 4AG-16V

COROLLA LEVIN/TRUENO/AE86/AE92



Thickness	Bore	Part No.	Type
0.60mm	82.50mm	CH112290-RC1	STOPPER
0.80mm	82.50mm	CH112290-RC0	
1.00mm	82.50mm	CH112290-RC2	

Metal Head Gasket For 4AG-20V

COROLLA LEVIN AE101(20V)

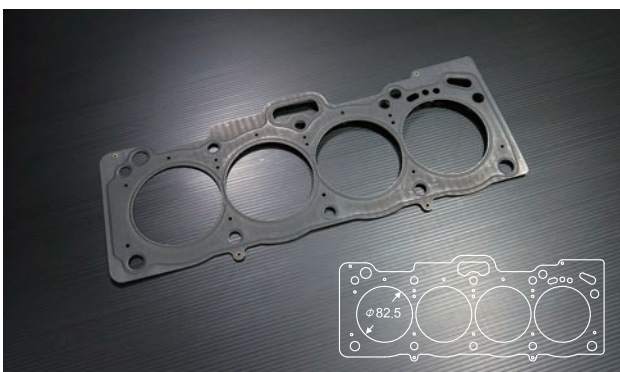

Thickness	Bore	Part No.	Type
0.60mm	82.50mm	CH112300-RC1	STOPPER
0.80mm	82.50mm	CH112300-RC0	
1.00mm	82.50mm	CH112300-RC2	

Metal Head Gasket For FA20 - L

GT86(4U-GSE), BRZ, FR-S

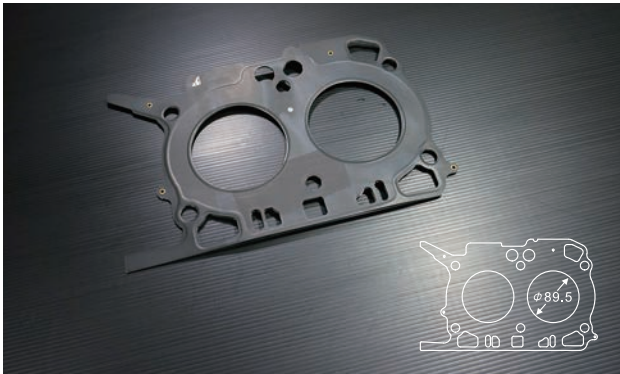

Thickness	Bore	Part No.	Type
0.80mm	89.50mm	CH230520-RA0 (L)	STOPPER
1.00mm	89.50mm	CH230520-RA1 (L)	
1.20mm	89.50mm	CH230520-RA2 (L)	
1.40mm	89.50mm	CH230520-RA3 (L)	

Metal Head Gasket For FA20 - R

GT86(4U-GSE), BRZ, FR-S



Thickness	Bore	Part No.	Type
0.80mm	89.50mm	CH230530-RA0 (R)	STOPPER
1.00mm	89.50mm	CH230530-RA1 (R)	
1.20mm	89.50mm	CH230530-RA2 (R)	
1.40mm	89.50mm	CH230530-RA3 (R)	

Exhaust Manifold Gasket For 1JZ-GTE

SUPRA 3 JZA70



Thickness	Bore	Part No.	Type
0.40mm	30.00mm	EX111390-RB0	BEAD

Exhaust Manifold Gasket For 1JZ-GTE

SUPRA 3 JZA70



Thickness	Bore	Part No.	Type
0.40mm	40.00mm	EX111391-RB0	BEAD

Exhaust Manifold Gasket For FA20 / FB20

GT86(4U-GSE), BRZ, FR-S



Thickness	Bore	Part No.	Type
1.15mm	46.50mm	EX230520-RA0	GROMMET

Turbo Gasket For 1JZ-GTE

SUPRA 3 JZA70

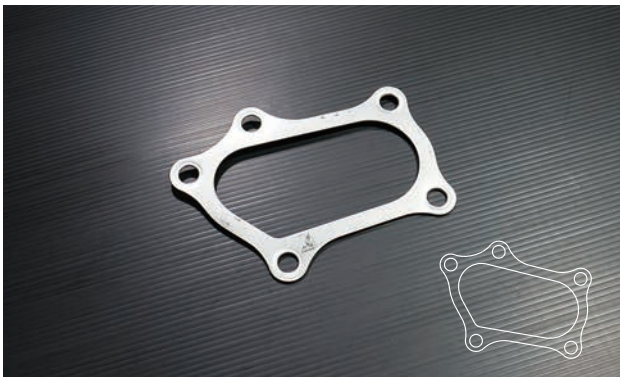

Thickness	Bore	Part No.	Type
2.00mm	N/A	TB111390-RA0	GROMMET

Full Set For FA20(NA)

GT86 2.0 BRZ 2.0 ,FR-S

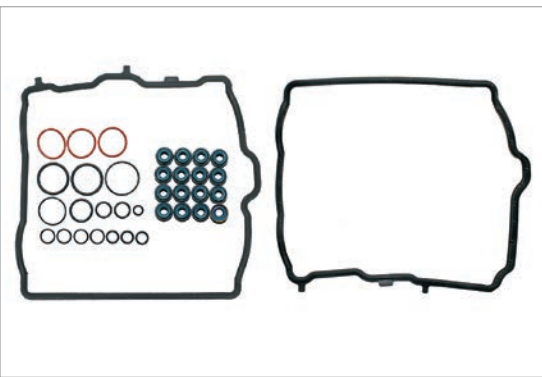

Part No.

FS230520-RZA

Full Set For 2JZ-GE

ALTEZZA GITA 3.0 ,ARISTO 3.0 ,SUPRA 3.0

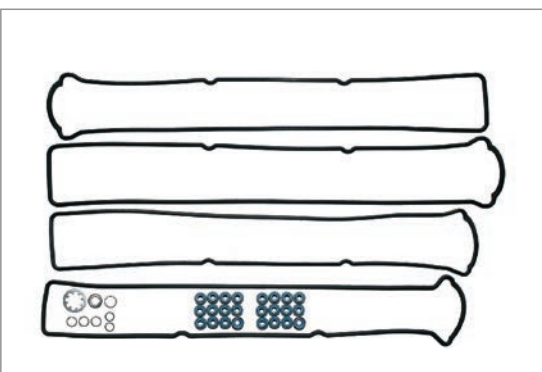

Part No.

FS110233-RZ0

MIDDLE Set For 2JZ-GTE

ALTEZZA GITA 3.0 ,ARISTO 3.0 ,SUPRA 3.0

Part No.

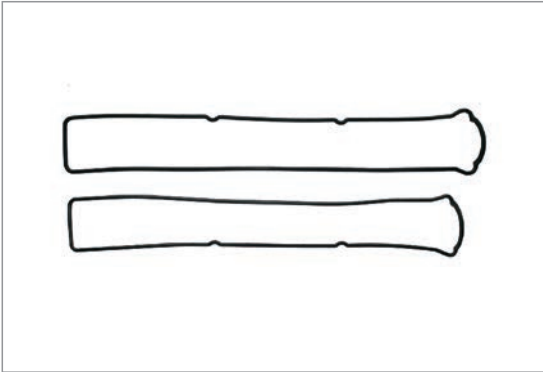
MS111441-R00

MIDDLE Set For 2JZ

ALTEZZA GITA 3.0 ,ARISTO 3.0 ,SUPRA 3.0

Part No.

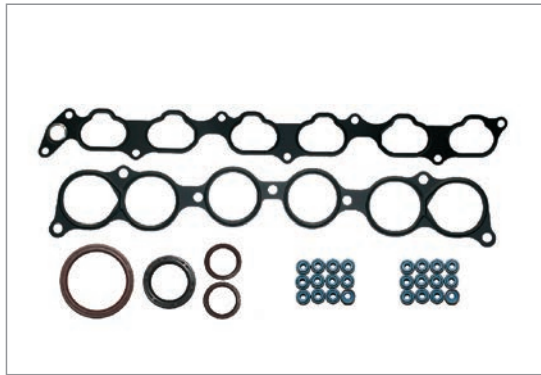
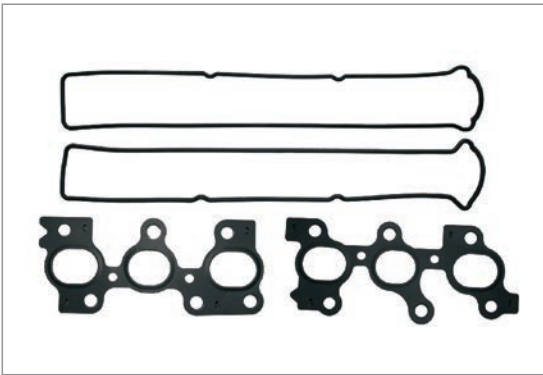
MS110231-R00

VOLKSWAGEN

SPECIFICATION VOLKSWAGEN

Metal Head Gasket For BZB (EA888)

GOLF GTI/GT R, A3, A4 TFSI 1.8T/2.0T

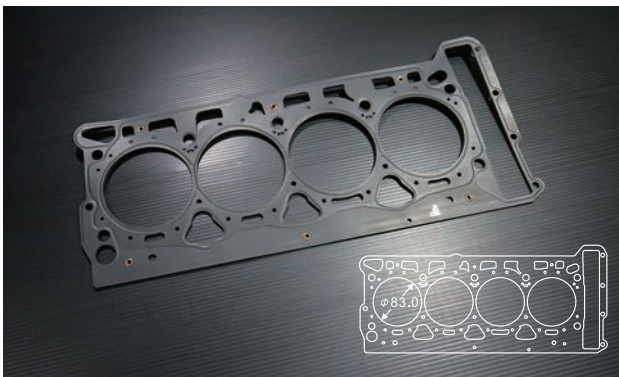

Thickness	Bore	Part No.	Type
1.00mm	83.00mm	CH200420-RE1	STOPPER

Metal Head Gasket For BV-R

2005.17-VW ARTEON(3H7) 2.9 TSI 1984 cc / 2.0 I

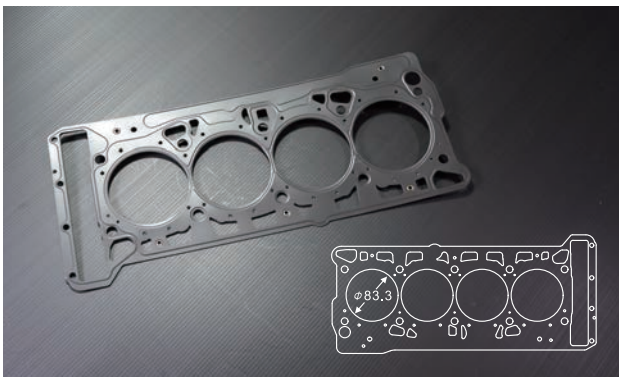

Thickness	Bore	Part No.	Type
1.05mm	83.30mm	CH200900-RA0	STOPPER
1.15mm	83.30mm	CH200900-RA1	
1.55mm	83.30mm	CH200900-RA2	

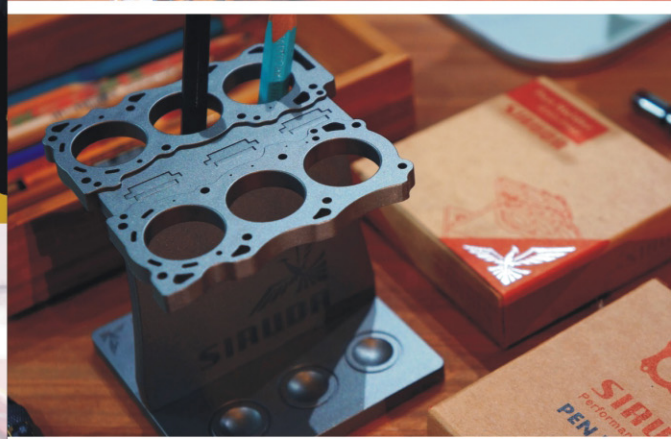

本格
技術

Revolution



SIRUDA
Performance Gaskets

 www.siruda.com

 info@siruda.com

  SIRUDA

